



INTERNET PAN & TILT WIRELESS HD IP CAMERA



User Manual
DN-16035

Table of Contents

<i>Chapter I: Familiar with your Internet IP Camera</i>	4
1.1 Package Contents	4
1.2 Basic Introduction	5
1.3 Product Highlights.....	6
1.4 Familiar with Key Components	7
1.5 Descriptions for LED Indicators	13
1.6 Camera Installation.....	13
1.7 Locate the IP Address of this IP Camera	18
1.8 Using Camera Admin Software to Locate Camera	22
<i>Chapter II: Using Web Management Interface</i>	34
2.1 Camera Settings	35
2.2 Video.....	39
2.2.1 MJPEG	40
2.2.2 MPEG4	41
2.2.3 H.264	42
2.2.4 OSD	43
2.2.5 Night Vision.....	44
2.3 Pan and Tilt.....	45
2.3.1 Preset Points	45
2.3.2 Grand Tour.....	47
2.4 Network Settings.....	50
2.4.1 LAN.....	51
2.4.2 WLAN	53
2.4.3 Dynamic DNS	56
2.4.4 UPnP	57
2.4.5 LoginFree	59
2.4.6 RTSP	60
2.5 Motion Detection.....	61
2.5.1 Motion Detection.....	62
2.5.2 Motion Region	64
2.6 System Info.....	71
2.6.1 Camera Information.....	72
2.6.2 Date / Time Setting	73
2.6.3 Utilities	75
2.6.4 Status.....	77
2.7 Account.....	78

2.7.1 Status.....	80
2.7.2 Space Alarm	81
2.7.3 File Management	83
<i>Chapter III: Using Surveillance Software</i>	<i>84</i>
3-1 Installing IP Camera Surveillance Software.....	84
3-2 Using IP camera surveillance software.....	88
3-3 Configure IP camera surveillance software	91
3-3-1 Configure cameras	91
3-3-2 General Settings.....	101
3-4 Change Display Layout.....	107
3-5 Full-screen mode.....	110
3-6 Scan	111
3-7 Zoom-in / Zoom-out.....	112
3-8 PTZ.....	113
3-9 Snapshot	114
3-10 Recording	115
3-11 Video Playback	116
<i>Chapter IV: Appendix</i>	<i>117</i>
4.1 Specification.....	117
4.2 Troubleshooting	118
4.3 Obtain a free DynDNS account	121
4.5 Use this IPCAM with a router or firewall	127
4.4.1 Setup DynDNS Dynamic IP address Mapping	127
4.4.2 Open Ports Required by IP CAM	128
4.5 Using Cellphone as Image Viewer.....	130
4.5.1 iPhone	130
4.6 Windows Vista / Windows 7 UAC Configuration	134

Chapter I: Familiar with your Internet IP Camera

1.1 Package Contents

Thank you for purchasing this IP camera! Before you start to use this IP camera, please check the package contents. If anything is missing, please contact the dealer of purchase and return the package to claim for missing contents.

	Item Name	Quantity
1	IP Camera	1
2	Antenna	2
3	Power Adapter	1
4	Ethernet Cable	1
5	Driver and User Manual CD-ROM	1
6	Accessory kit	1
7	Quick Installation Guide	1

1.2 Basic Introduction

Thank you for purchasing this Internet IP camera! This IP camera is an ideal product for all kinds of video-surveillance purposes, like home/office safety, kid/pet monitoring, and remote video acquire etc. Unlike conventional close-circuit video camera; you're not limited to the length of cable! Once this IP camera is connected to Internet, you can receive video from anywhere in the world where Internet access is available.

If you have problem installing a new cable from the place the camera is installed to your monitoring computer, don't worry! This IP camera also supports wireless network, that is, you can link to this camera wirelessly! You only have to provide this IP camera with 12V power by the power adapter that comes with the product package, and you don't have to set a new network cable between the IP camera and monitoring computer.

Worry about the content will be intercepted by unauthorized person when the video is transmitted over the air? That's also not a problem! Unlike conventional analog wireless camera, which video will be intercepted by anyone who got a compatible video receiver, this IP camera supports data encryption (WEP & WPA), which will provide ultimate data security level. All video transmitted over the air is encrypted; therefore no one will be able to get the video captured by the IP camera, expect yourself.

Some people may concern that there will be some places which will not be covered by camera, but this problem is completely solved by this IP camera. With built-in pan-tilt function, you can point the camera to the position where you wish to look at with user interface. You can even define a preset path, and the camera will cruise along the path you defined.

If the environment is too dark, it's also not a problem. This camera equips 9 IR-LEDs and will illuminate automatically when the environment is too dark, and the image captured by this camera will still be clear.

You can discover more useful functions in next section!

1.3 Product Highlights

- No pre-loaded software required - all you need is a browser like Internet Explorer 6 (and above, with plugin installed).
- With supplied video surveillance software, you can connect up to 16 video cameras and view images captured by every camera at the same time.
- Supports 3 video resolutions: MJPG and H.264 SXGA(1280 x 1024), VGA (640 x 480), and QVGA (320 x 240); MPEG4 XGA (1024 x 768), VGA (640 x 480), and QVGA (320 x 240).
- Anti-flicker function (eliminates flash caused by fluorescent lights, 50 / 60Hz selectable).
- Video control functions, like brightness and zoom-in / zoom-out.
- Audio function, suitable for applications like video conference or environment monitor.
- 9 automatically-controlled IR LEDs.
- Wired and wireless network (802.11b / 802.11g / 802.11n) support, supports up to 100Mbps for wired network and 100Mbps for wireless network.
- Wireless data encryption (WEP / WPA)
- Supports DHCP and PPPoE protocol, you can also assign a fixed IP address to the camera also.
- Supports Dynamic DNS (used to allocate the IP camera's Internet address, when the ISP you're using does not assign you with a fixed Internet address).
- Supports UPnP, Windows XP (and above) will discover this IP camera in network neighbor automatically.
- Send captured picture and video by Email or FTP when motion is detected.
- Configurable motion detection sensitivity (6 levels from most sensitive to least sensitive).
- Built-in real-time clock, date and time information will be recorded with every captured picture / video clip (also supports auto time synchronization via network time protocol).
- Upgradeable firmware - enjoy new functions without buying a new camera!
- Supports up to 16 users, and you can set different password to different user.
- Usage and event logging.

1.4 Familiar with Key Components

Front View

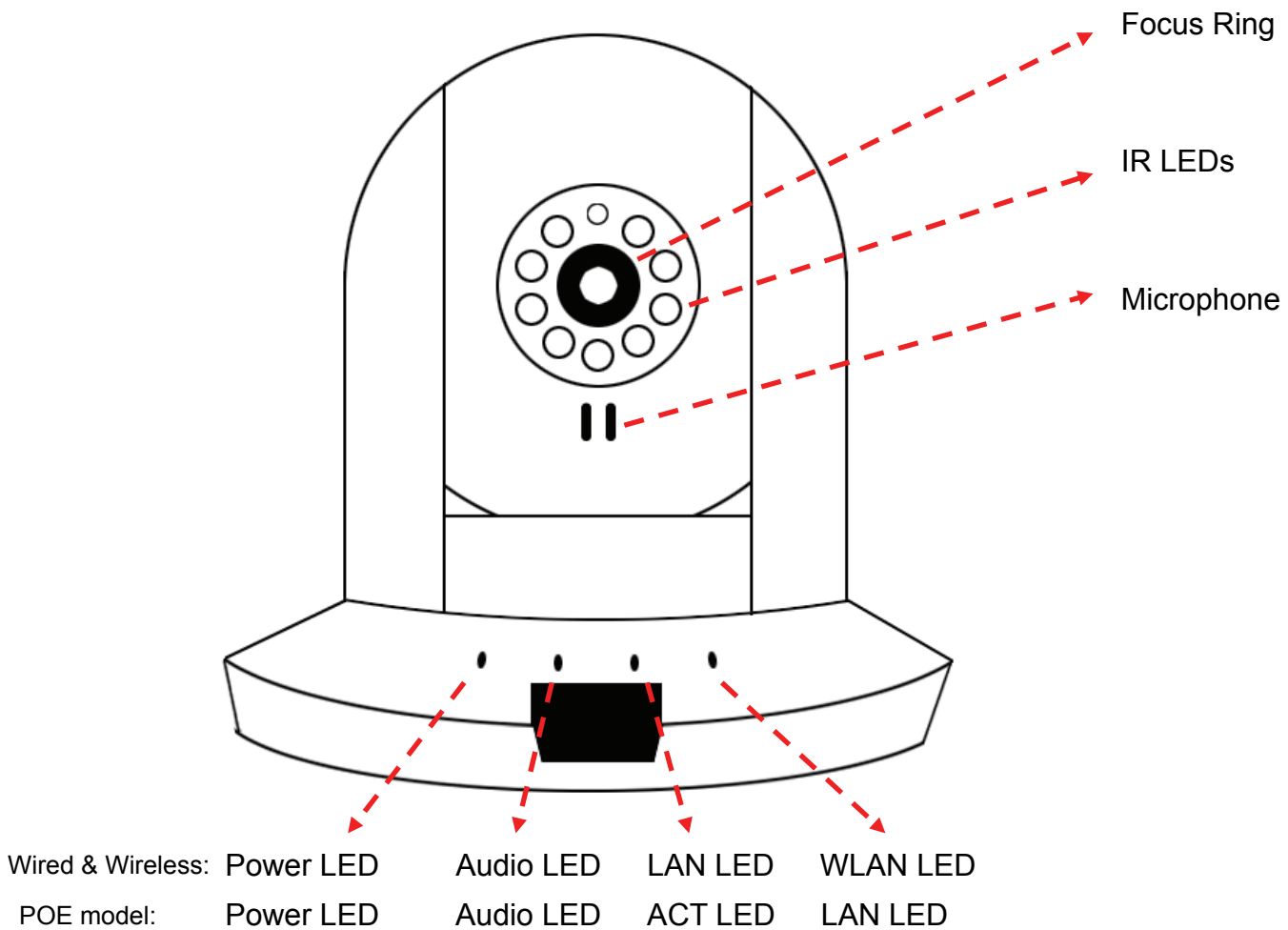

Power LED: Indicates power status

Audio LED: Indicates Audio status

LAN LED: Indicates LAN activity

ACT LED: Indicates Data activity

WLAN LED: Indicates Wireless LAN activity

Focus Ring: Adjusts focus

IR LEDs: Lights up when environment is too dark

Microphone: Collects audio

Back View

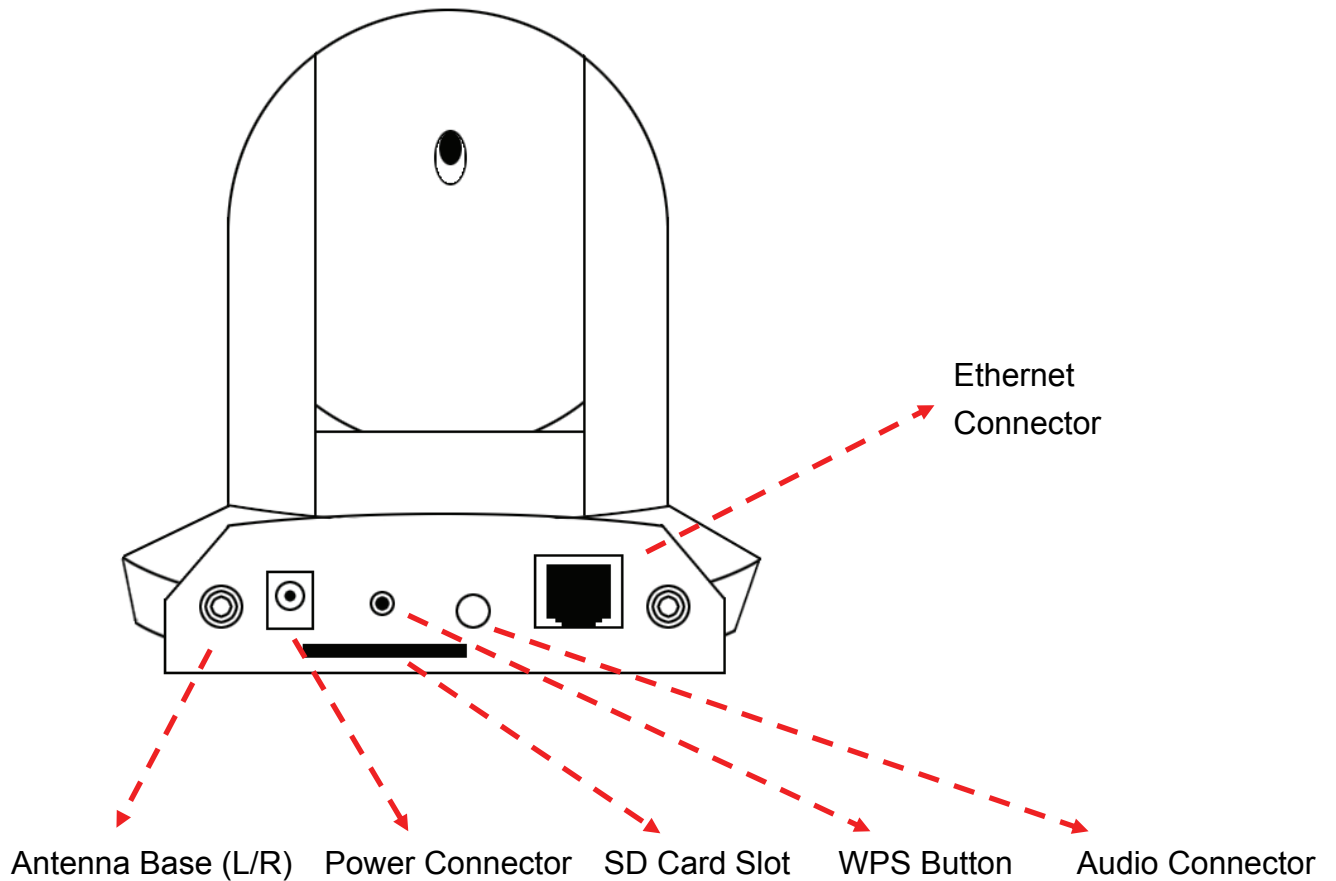

Antenna Base: Connects to supplied antenna

Power Connector: Connects to 12V DC power adapter

SD Card Slot: Accepts SD / SD-HC memory card for image / video storage

WPS Button: click the button on IP Cam and click it on the AP you want to connect for wireless

Audio Connector: Connects to external speaker for audio output

Ethernet Connector: Connect to your local area network

Back View of Wired model

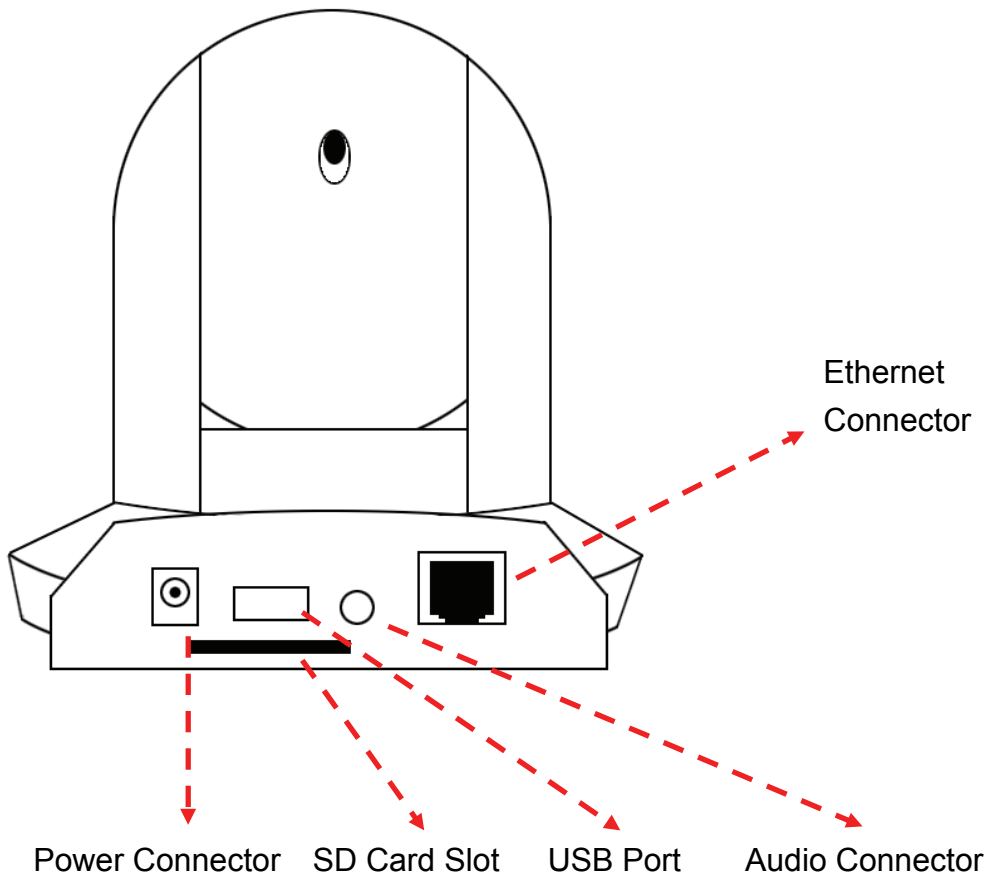

Power Connector: Connects to 12V DC power adapter

SD Card Slot: Accepts SD / SD-HC memory card for image / video storage

USB Port: Connects to certain wireless module.

Audio Connector: Connects to external speaker for audio output

Ethernet Connector: Connect to your local area network

Back View of POE model

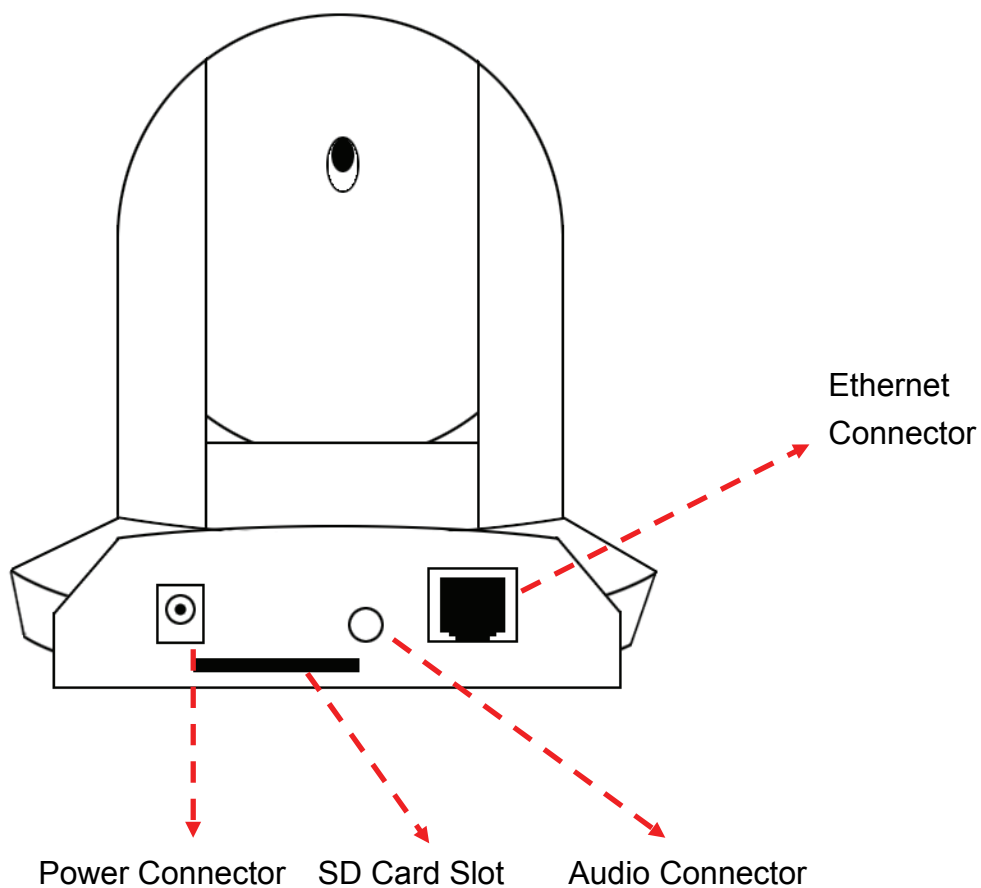

Power Connector: Connects to 12V DC power adapter

SD Card Slot: Accepts SD / SD-HC memory card for image / video storage

Audio Connector: Connects to external speaker for audio output

Ethernet Connector: Connect to your local area network

Side View

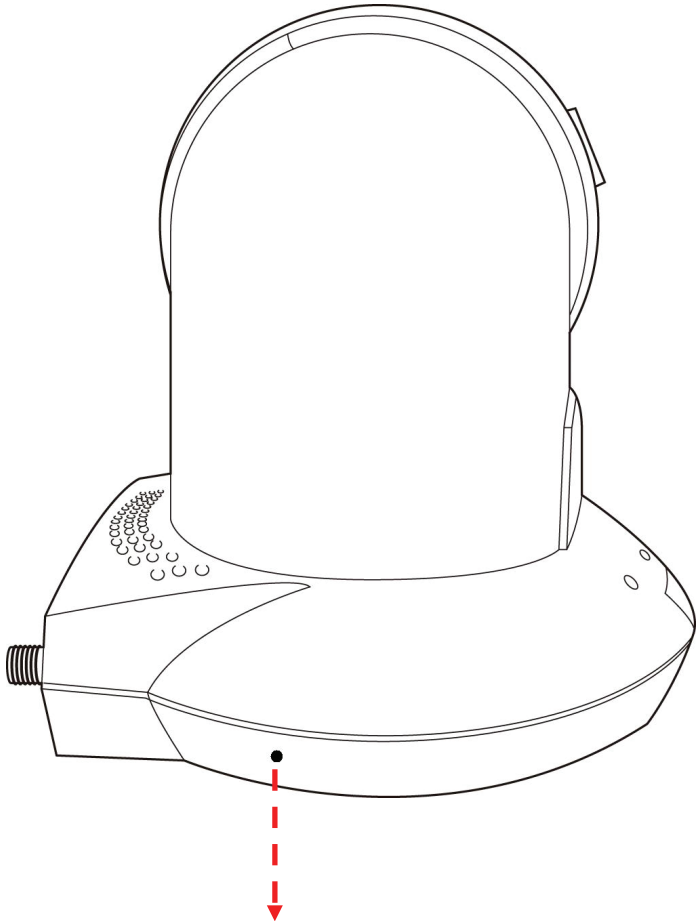

Reset Button

Reset Button: Press the button with pen nib and hold for 5 seconds to reset the camera settings to factory default value.

Bottom View

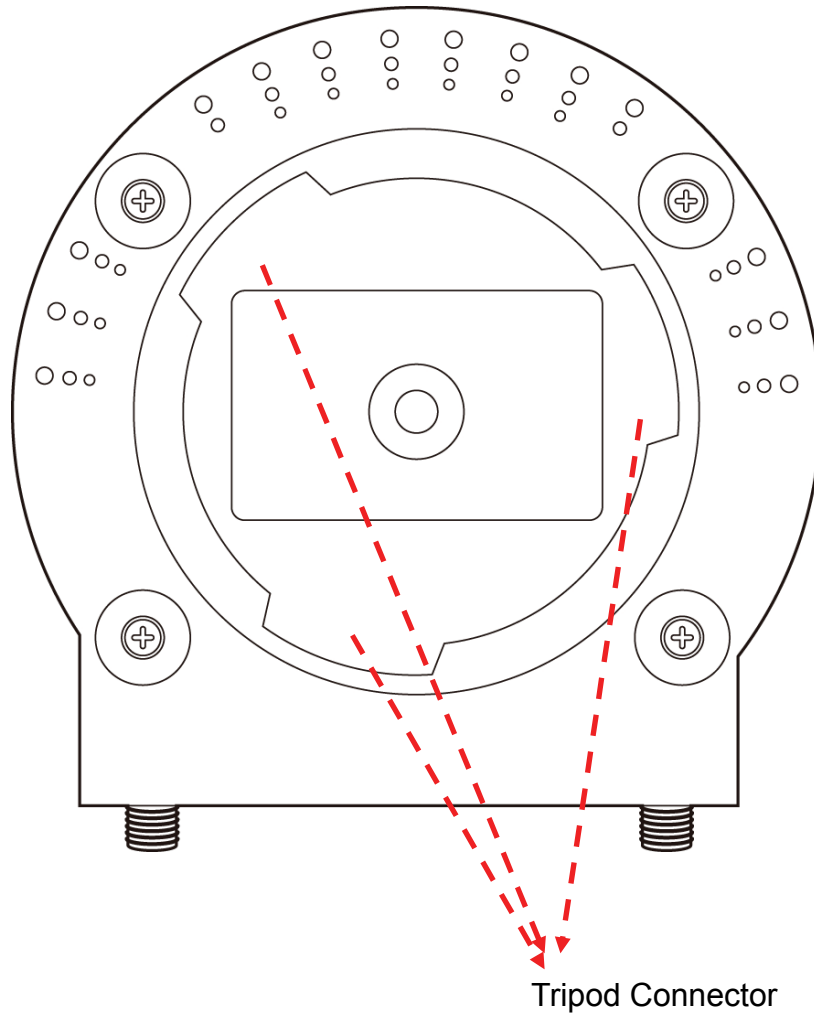

Tripod Connector: Connects to tripod to secure the camera when the camera is not put on a horizontal surface.

1.5 Descriptions for LED Indicators

Wired and Wireless model

LED Name	Status	Description
Power	Off	Camera is not powered (camera off)
	On	Camera is correctly powered (camera on)
LAN	Off	LAN port not in use
	On	LAN port in use
	Flash	Transferring data via LAN port
WLAN	Off	Wireless LAN not in use
	On	Wireless LAN in use
	Flash at low speed	Waiting for WPS connection from AP and flash speed is once a second.
	Flash	Transferring data via wireless LAN
Audio	Off	Audio function is disabled (Volume 0)
	On	Audio function is enabled
	Flash	Two way audio is working

POE model

LED Name	Status	Description
Power	Off	Camera is not powered (camera off)
	On	Camera is correctly powered (camera on)
ACT	Off	No data is transferred
	On	Transferring data
LAN	Off	LAN port not in use
	On	LAN port in use
Audio	Off	Audio function is disabled (Volume 0)
	On	Audio function is enabled
	Flash	Two way audio is working

1.6 Camera Installation

Please follow the following instructions to set your IP camera up.

1. Unpack the product package and check if anything's missing.
2. Connect the Ethernet cable to your local area network, and connect the other end to the LAN jack of this IP camera.

NOTE: *You can skip this step if you plan to use wireless LAN only.*

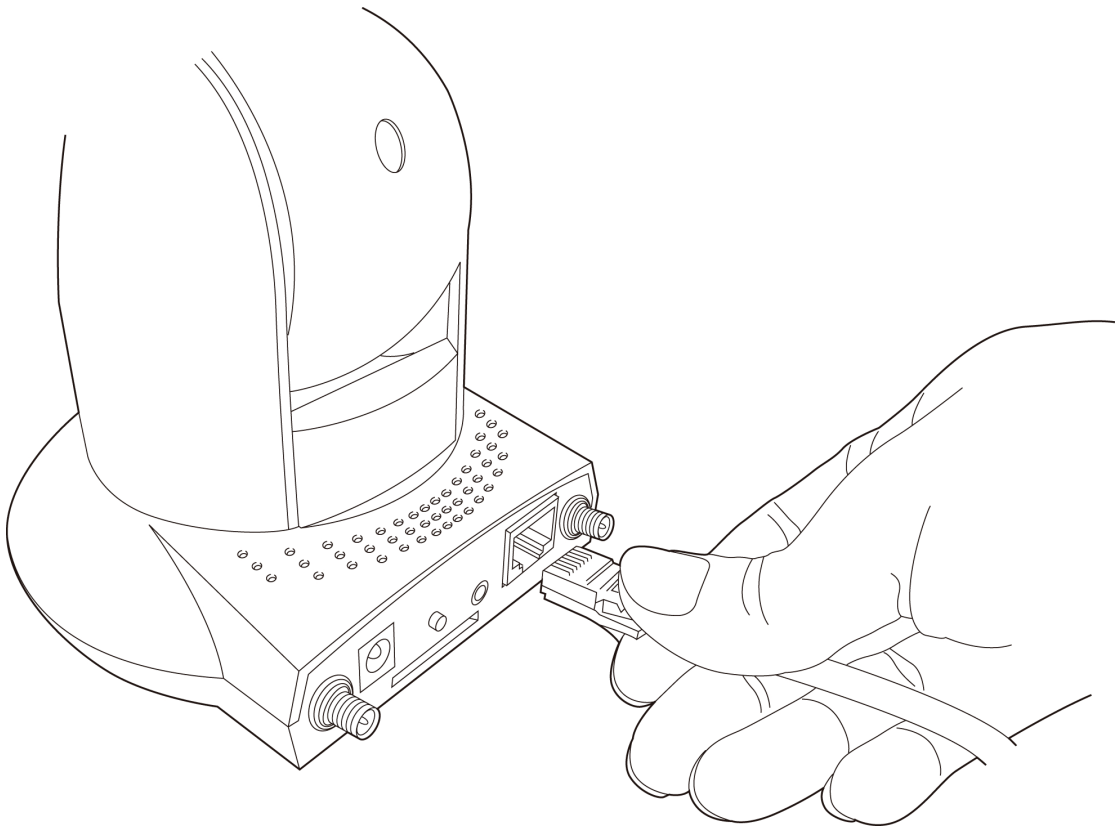

3. Plug the power adapter to wall socket, and connect the power connector to the power jack located at the bottom of the IP camera.

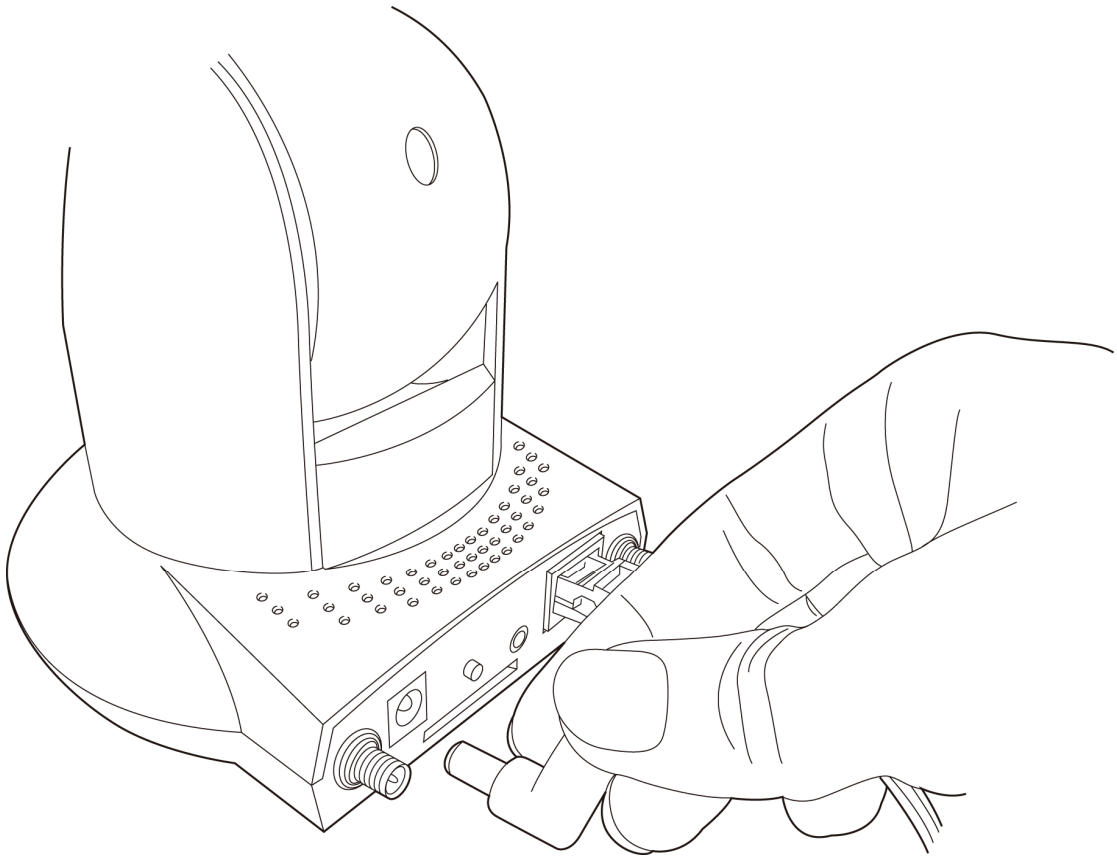

4. Connect two antennas to the antenna bases, which is located at the back of this IP camera.

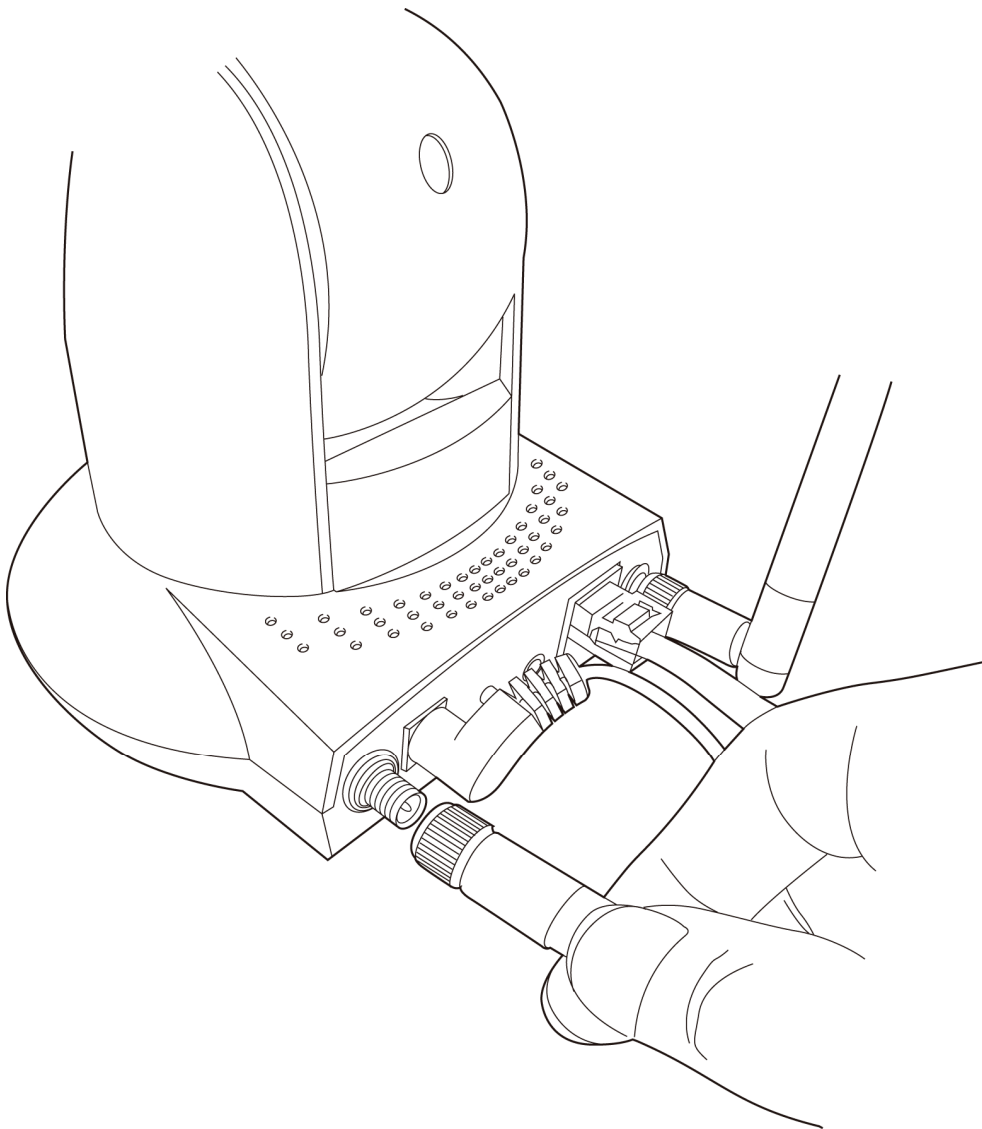

5. Place the camera at a secure place, and point the camera to the place you wish to monitor. If you wish to hang the camera on the ceiling or wall, please use the tripod connector (located at the bottom of the camera) to secure the camera.

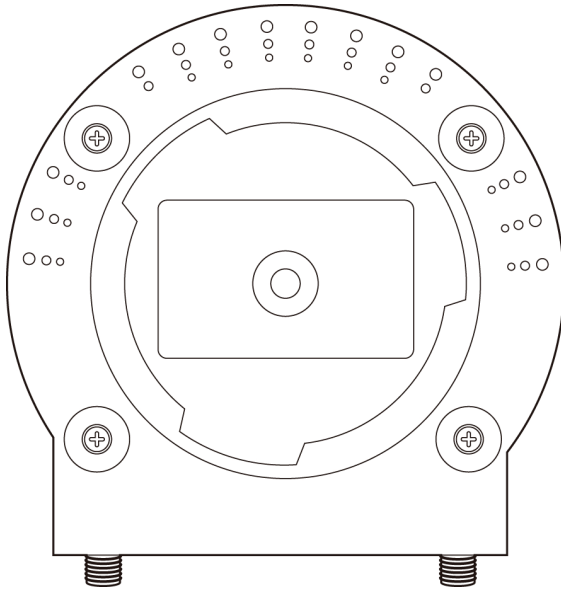

6. Launch Internet Explorer on your computer, and following the instructions given in next section to set the IP camera.

1.7 Locate the IP Address of this IP Camera

Default IP address of this IP camera is 192.168.2.3. If you wish to assign another IP address to this IP camera, you have to log onto the web configuration interface of the camera first.

If the left three fields of the IP address of your computer is not 192.168.2, you'll have to change the IP address of your computer first:

1. Click 'Start' -> 'Control Panel'

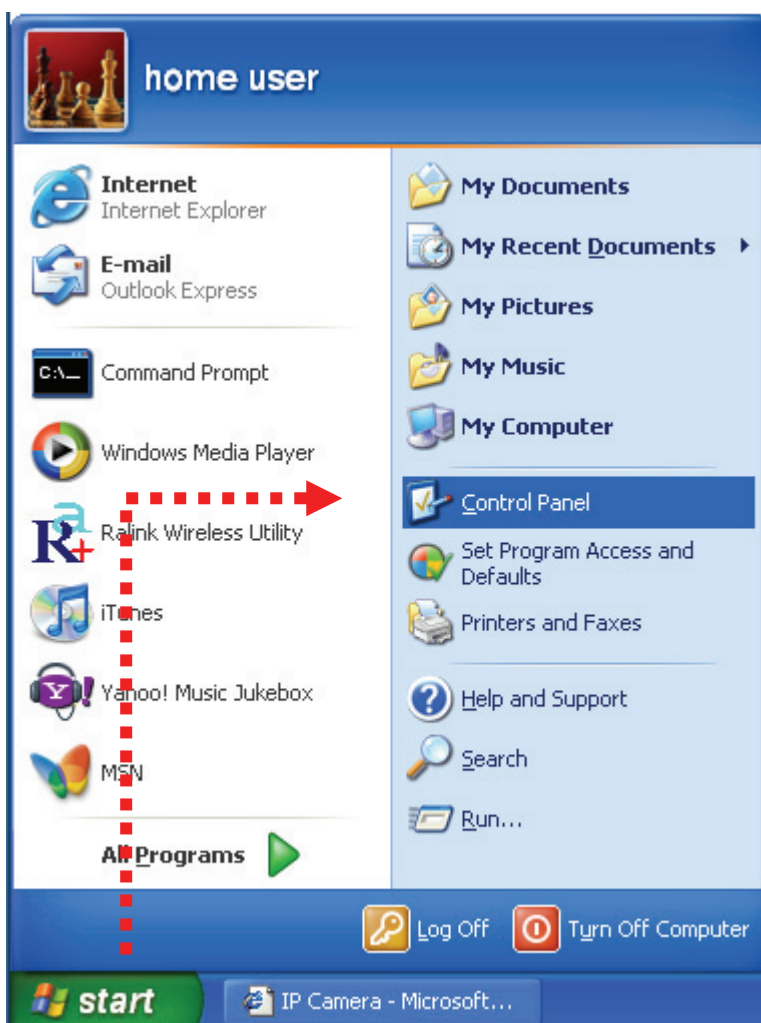

2. Double-click 'Network Connections' icon.

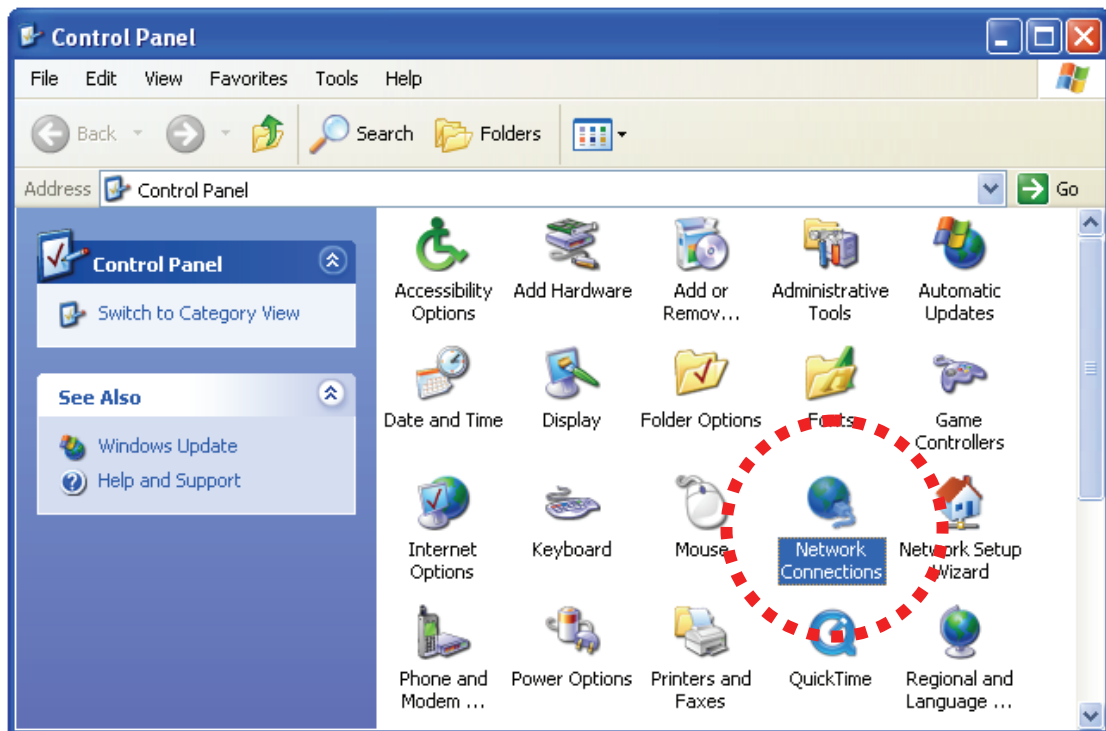

3. Right-click 'Local Area Connection', and click 'Properties'.

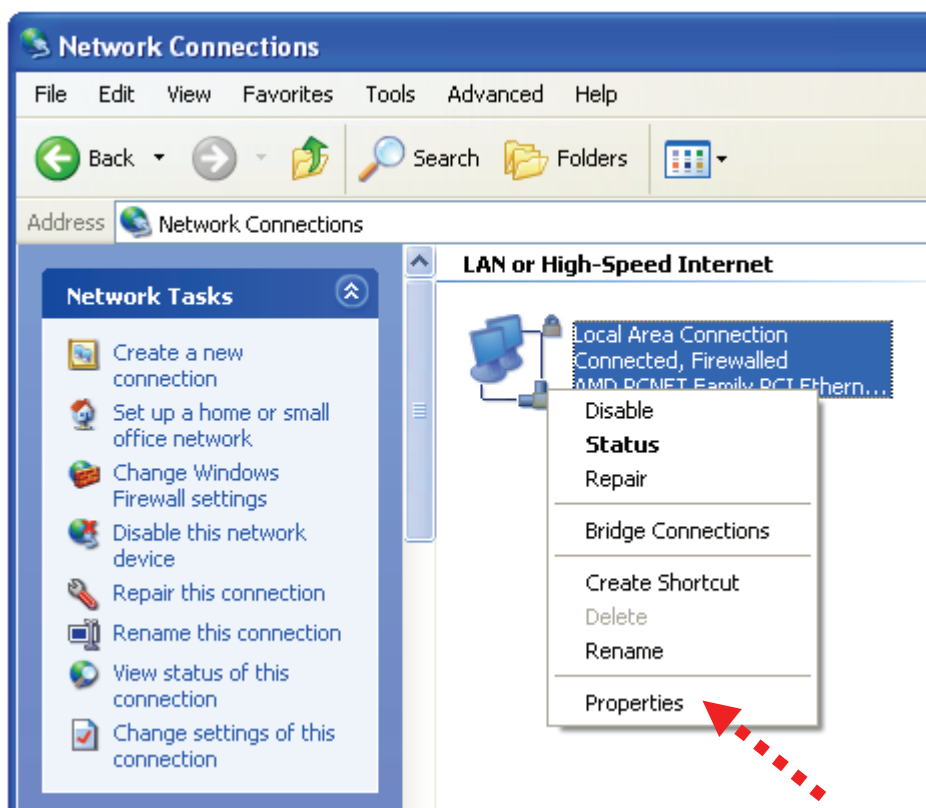

4. Select 'Internet Protocol (TCP/IP)', then click 'Properties'.

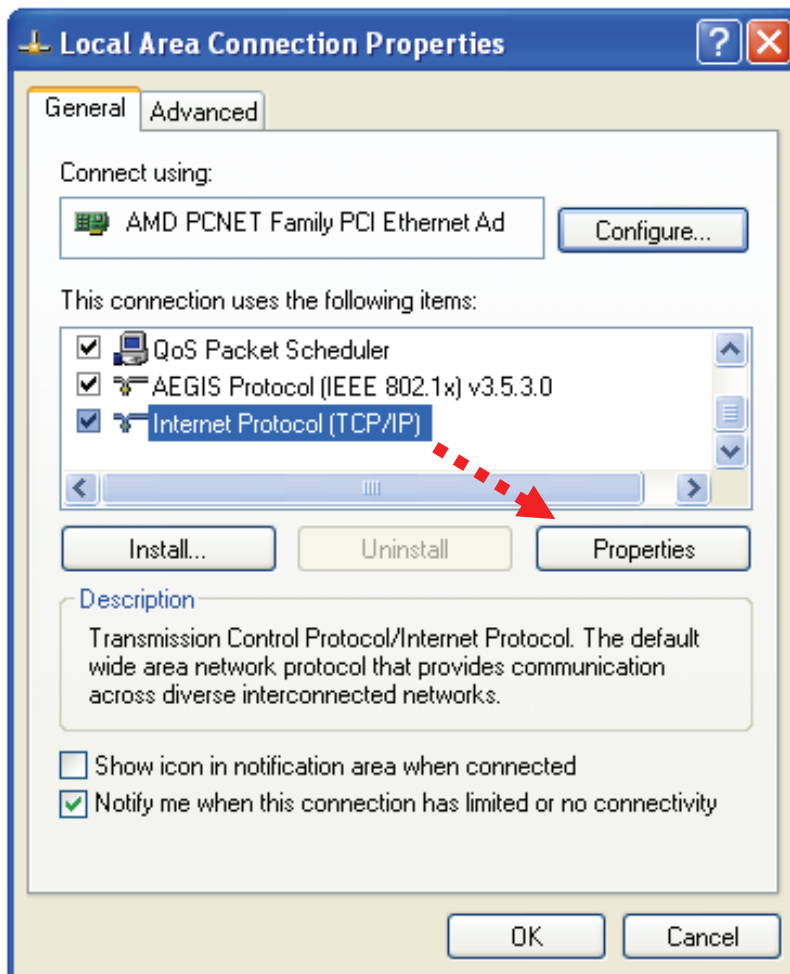

5. In 'IP address' field, please fill in any IP address begins with '192.168.2', and ends with a value greater than 2 and less than 254 (You can use the example in the picture '192.168.2.339'). In Subnet mask field, please fill '255.255.255.0'. Please keep all other fields empty, and click 'OK'.

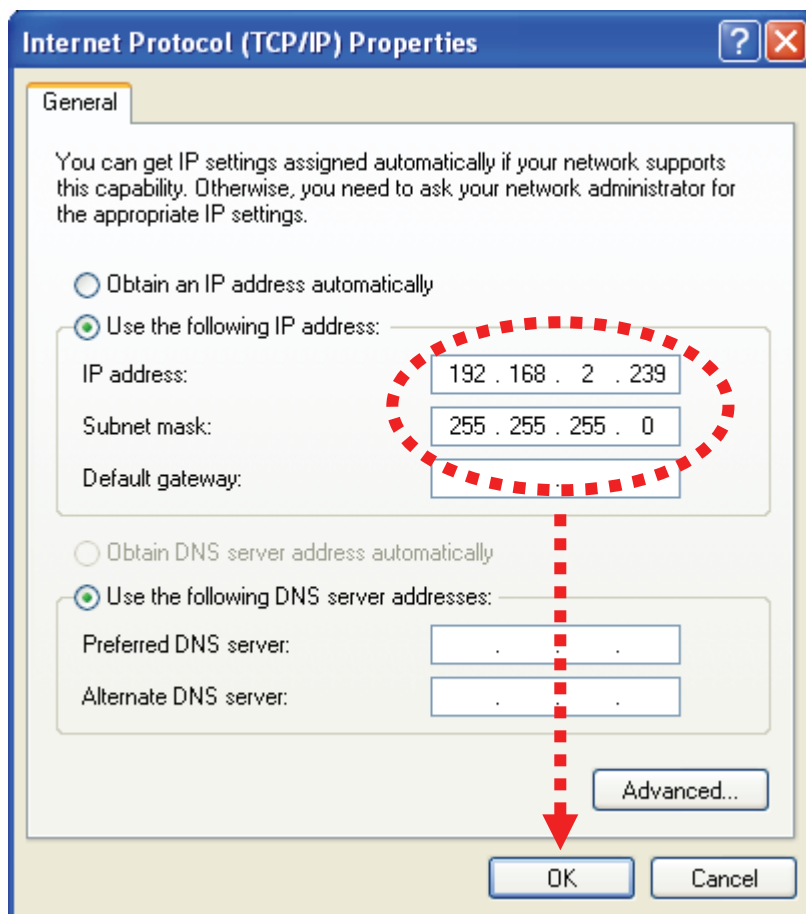

If you changed the IP address of this IP camera and you forget it, there're 2 methods to recover it:

- a. Press and hold the 'Reset' button located at the bottom of this IP camera, to clear all settings of the IP camera and reset the IP address back to 192.168.2.3. You'll lose all settings in the IP camera.
- b. Ask network administrator to check the DHCP release table, if the camera was set to obtain the IP address by DHCP, a new record will be added to DHCP release table on DHCP server when the IP camera is connected to the local area network.

1.8 Using Camera Admin Software to Locate Camera

If you can't connect to the camera by the instructions given in last chapter, you can use camera admin software to search the camera which is connected to your local area network. The admin software is also capable to locate multiple cameras on your local area network.

Please insert the user manual CD-ROM supplied in the product package, and the CD will automatically running the installation, if not please double-click 'Setup_Admin_3.0.1' icon:

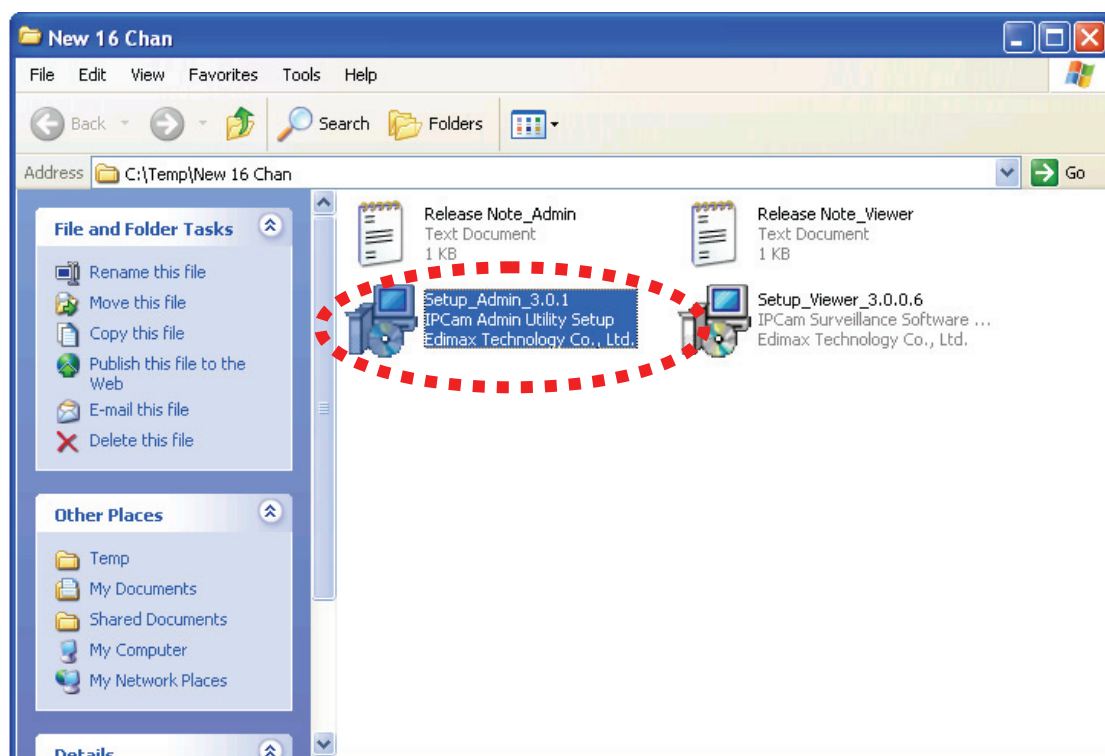

Then follow the following instructions to install and use camera admin software:

1. Click 'Next' to start install camera admin software:

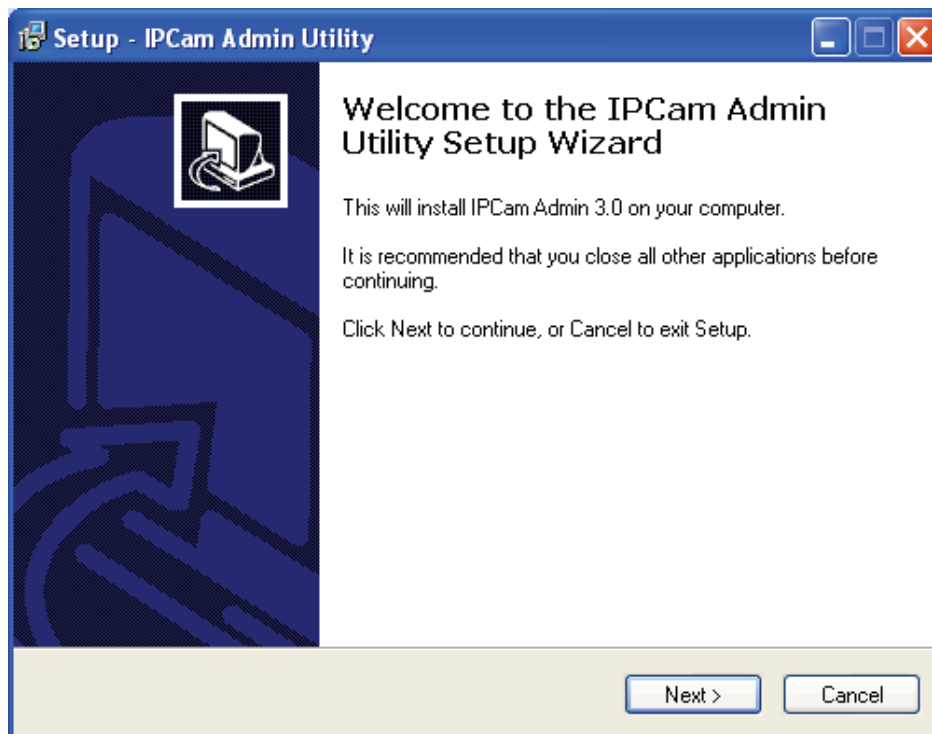

2. You can change the installation folder of camera setup software here, click 'Browse' to select an existing folder, or you can just click 'Next' to use default installation folder:

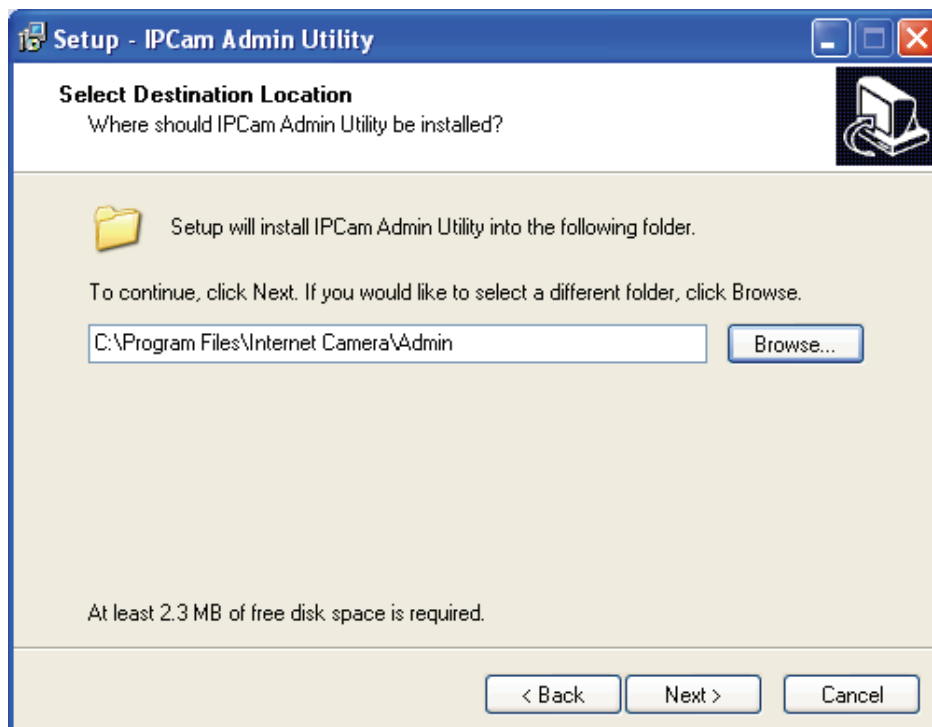

3. If you wish to create desktop icon and / or quick launch icon for camera admin software, please check corresponding box, and click 'Next' to continue.

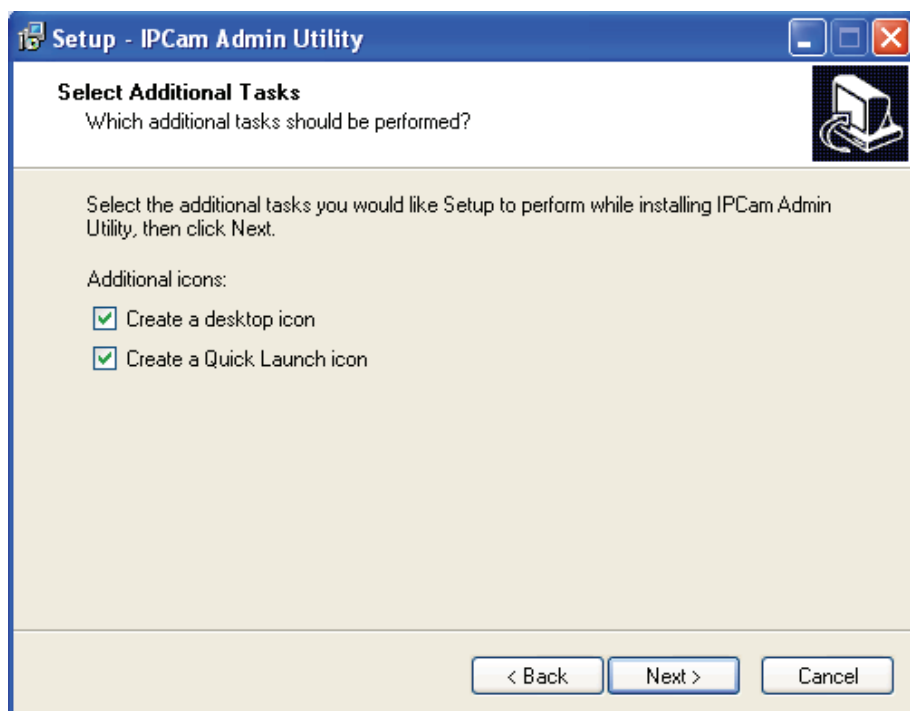

4. You'll see a brief of all options you selected, click 'Install' to install camera admin software now, or click 'back' to back to previous steps to change settings.

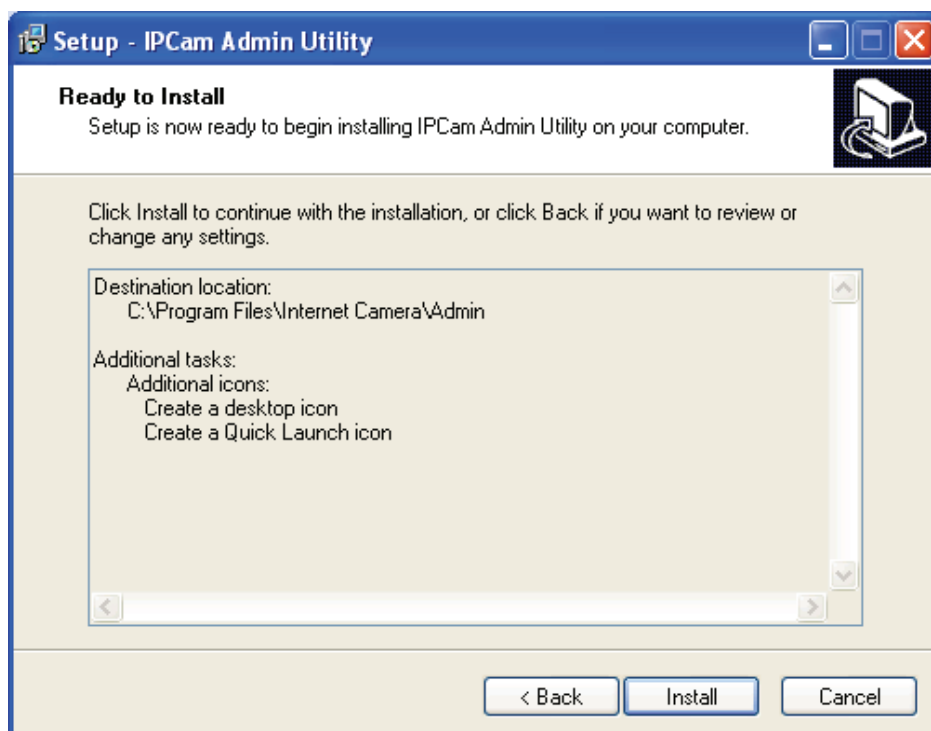

5. When you see this message, the installation of camera admin software is complete. If you wish to launch camera admin software now, keep 'Launch IP Cam Admin Utility' box checked, and click 'Finish' to close installation utility.

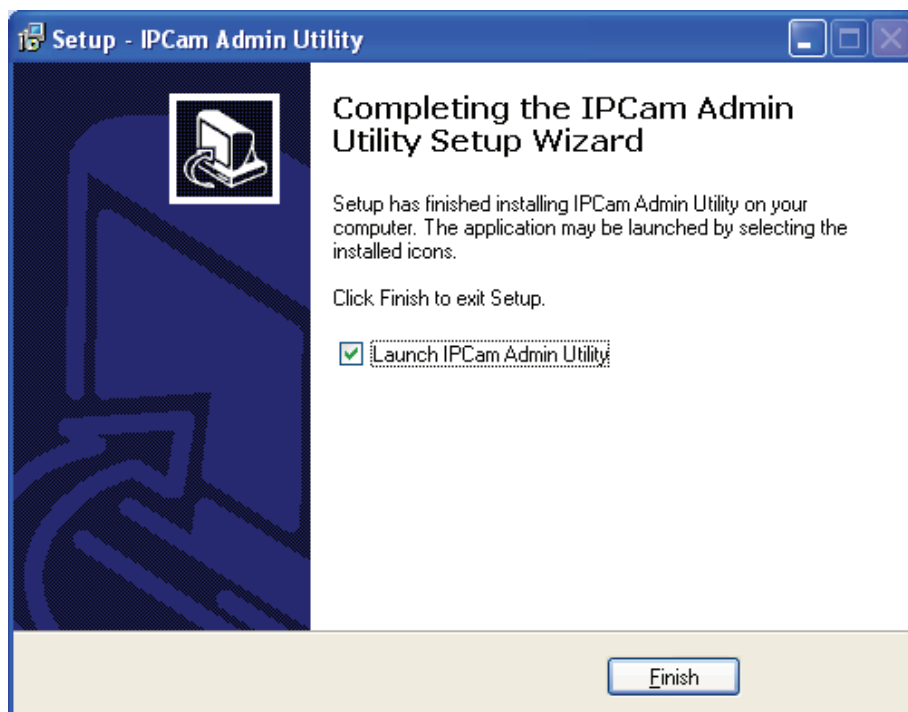

After the camera admin software is launched, all cameras found on your local area network will be displayed:

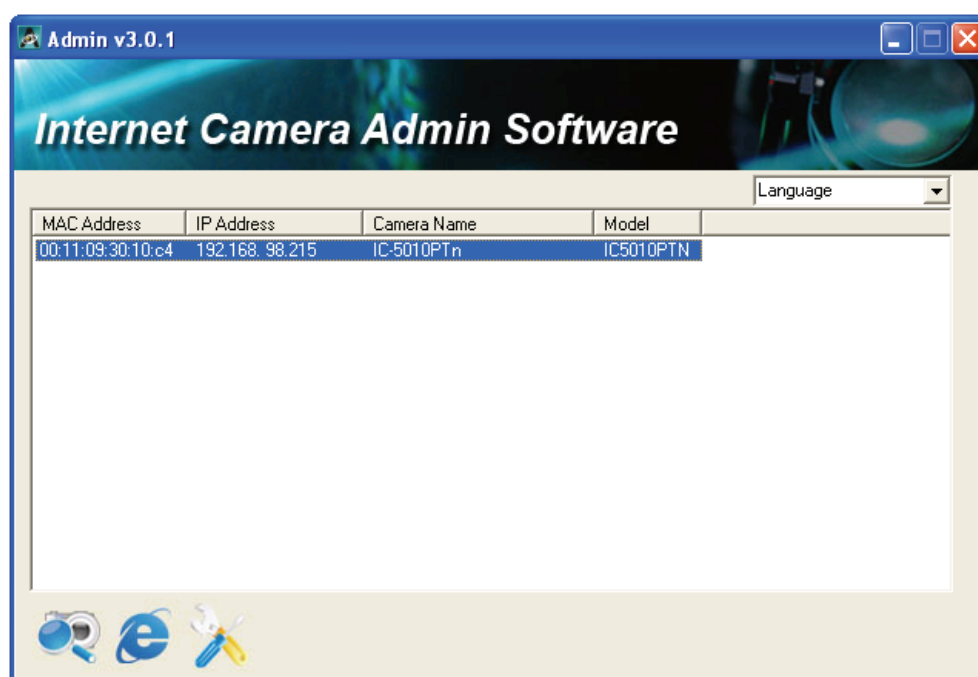

All camera-related information will be displayed here. If you wish to connect to certain camera by web browser, double-click the camera listed here.

The camera admin software also provides several functions:

Language change: This camera admin software supports 3 languages: English, Chinese, and Japanese. You can select the language you wish to use from language dropdown menu located at upper-right corner of camera admin software.

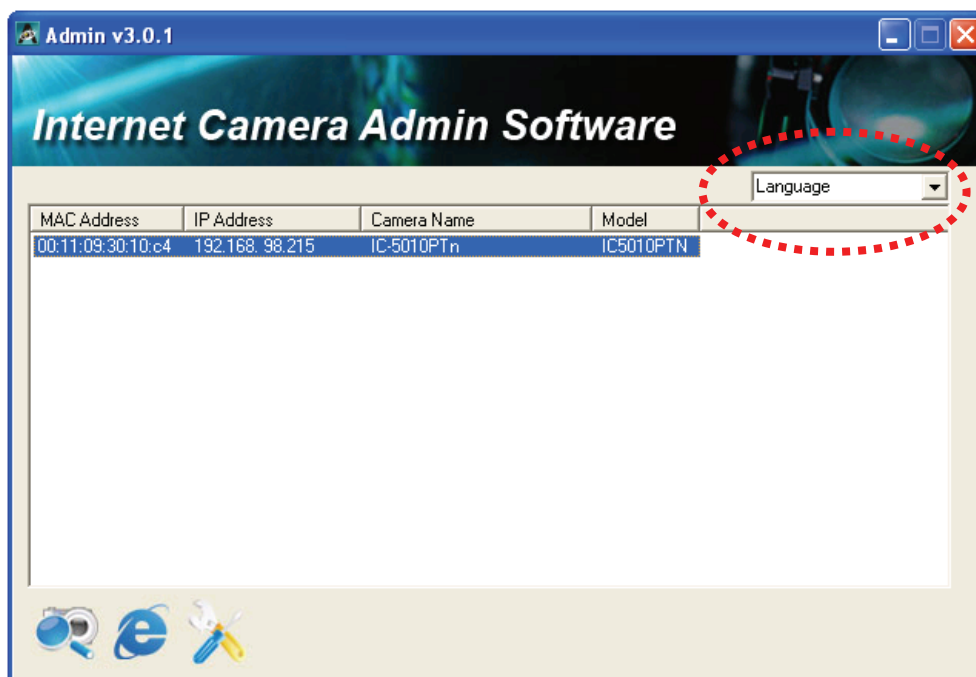

Search camera: Click this button to search all cameras on local area network again.



Browse camera via web: Select a camera listed above first, and then click this button to connect to the camera by web browser.

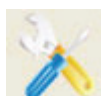

Configure camera: Click this button to configure camera's network and security setting. You'll be prompted to input camera's password:

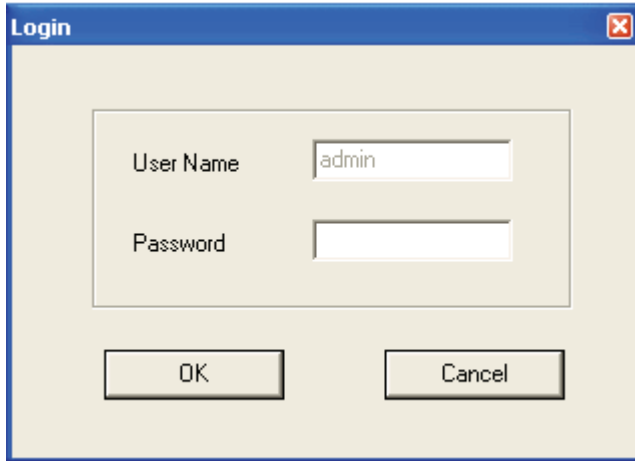

Input the password (default: 1234) and click OK to configure the camera's network and security setting:

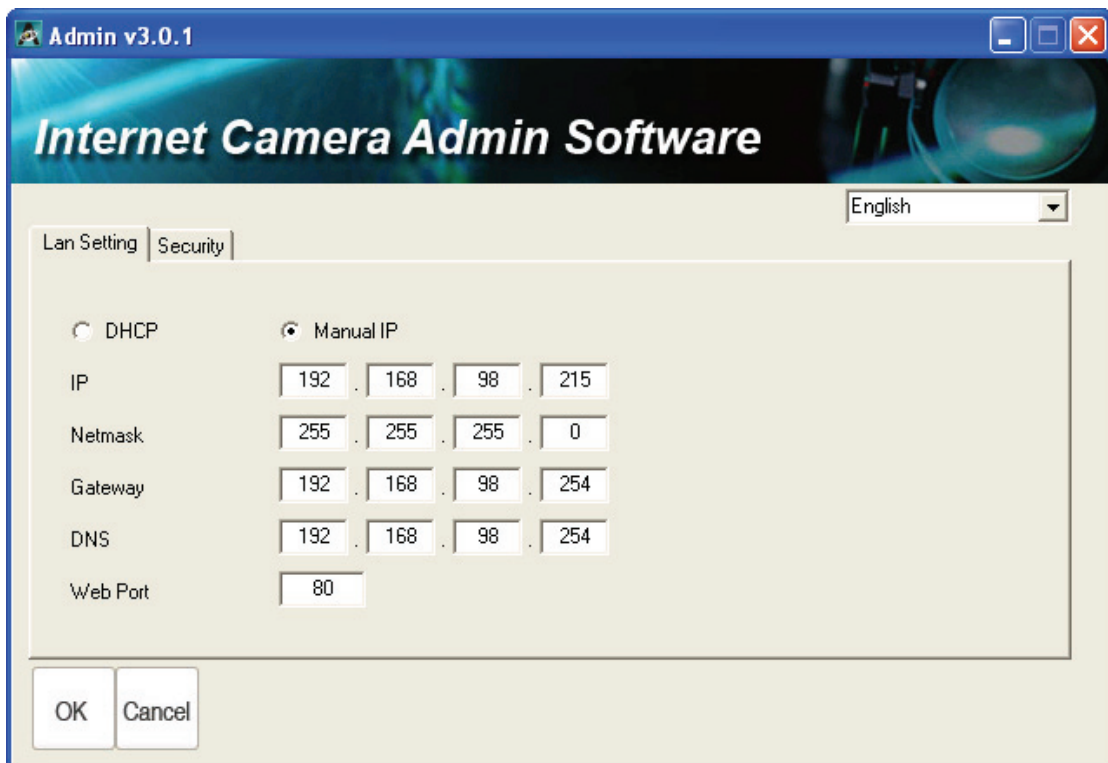

In 'Lan Setting' page, you can configure camera's network settings. Select 'DHCP' to set the camera to obtain an IP address from DHCP server on local area network automatically, and select 'Manual IP' to input the IP address information manually. Click 'OK' to save settings.

In 'Security' page, you can change the camera's name and password (user name is always 'admin' and cannot be changed). You have to input the same password in both 'New Password' and 'Confirm Password' field, or you'll be prompted to input new password again. Click 'OK' to save settings or click 'Cancel' to discard changes.

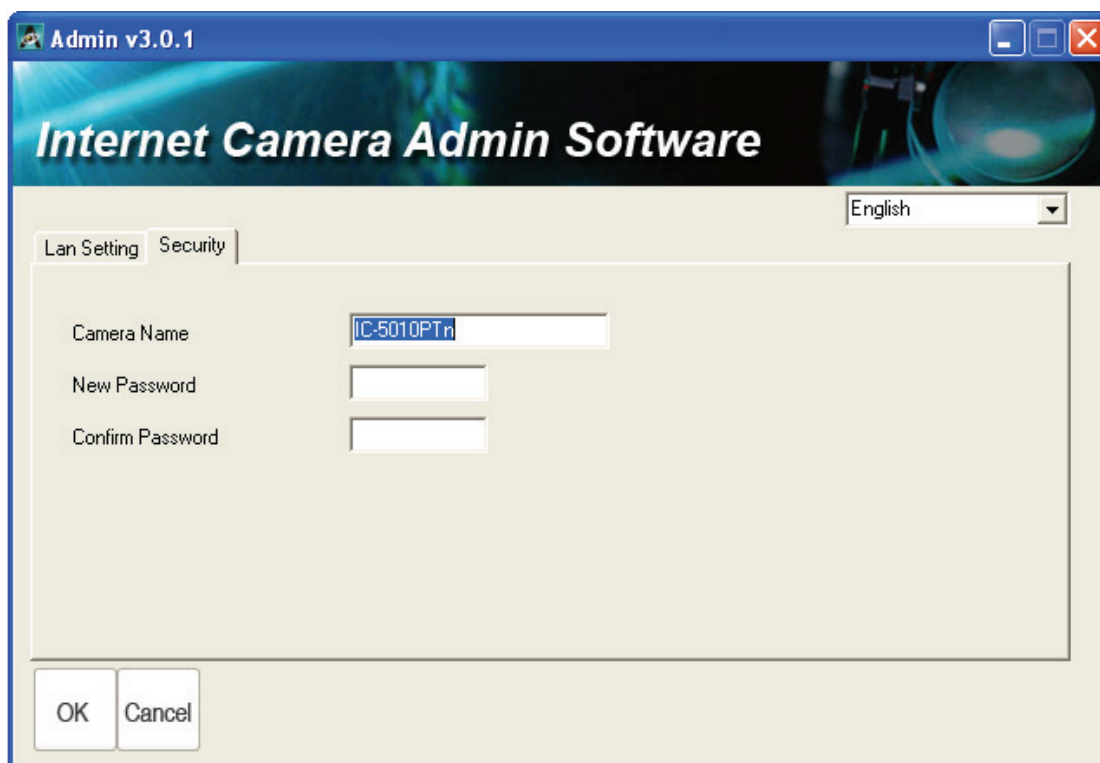

1.9 Log Onto Web Management Interface

Make sure the IP camera is correctly powered (Power LED is on), and then launch Internet Explorer and type the IP address of the IP camera in address bar of Internet Explorer. You should be prompted to input the user name and password:

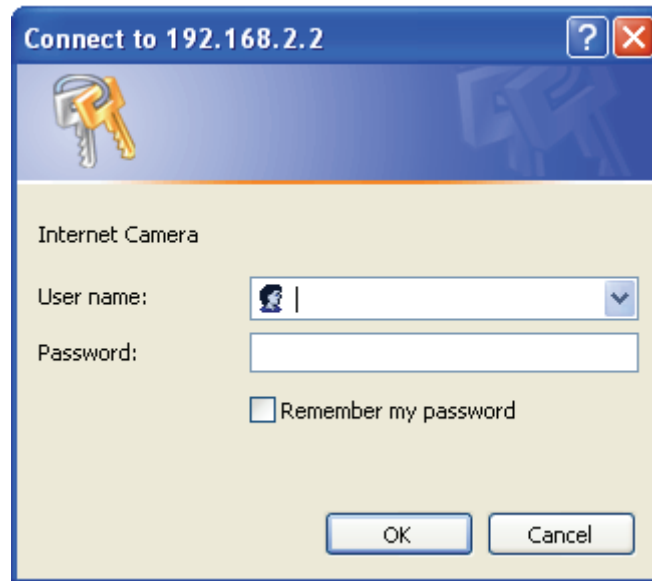

Default user name is 'admin' and password is '1234'. Click 'OK' to continue after user name and password has entered.

If you're rejected, maybe the password has been modified previously. This should not happen if this is a newly-purchased camera, however, if you get the camera from someone else, the password would be changed. Please try to obtain the correct user name / password, or you'll have to reset the camera.

If this is the first time you log onto web management interface, you'll be prompted to install ActiveX Plugin:

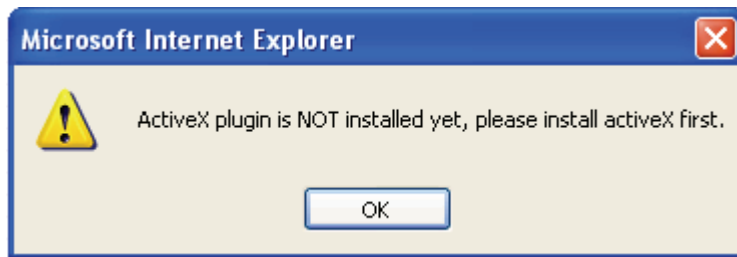

When you see this message, please click 'OK', and click 'Download the latest ActiveX' link to download plugin so you can use this camera:

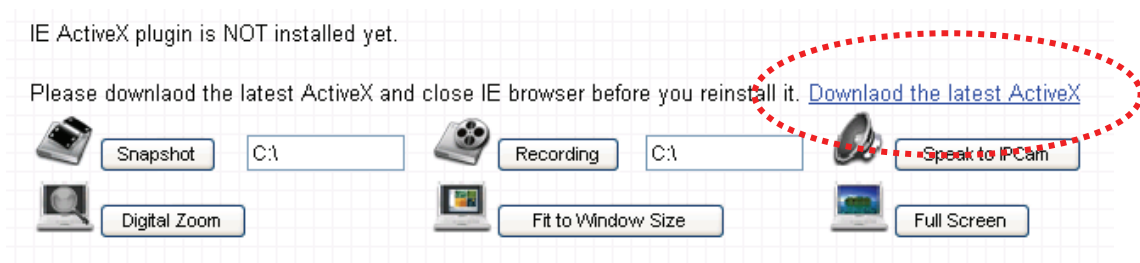

Click 'Run' to download plugin:

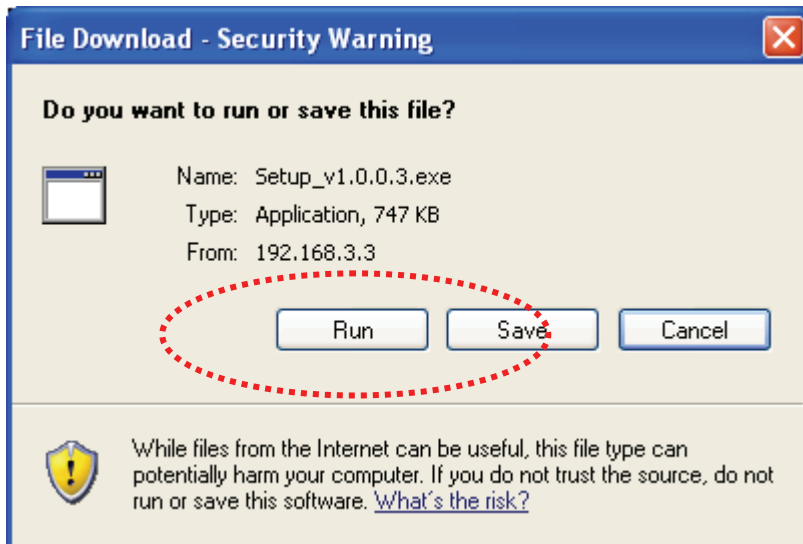

Click 'Run' to install plugin:



Please click 'Next' button to start installation (click 'Next' or 'Install' when you're prompted, until installation is complete).

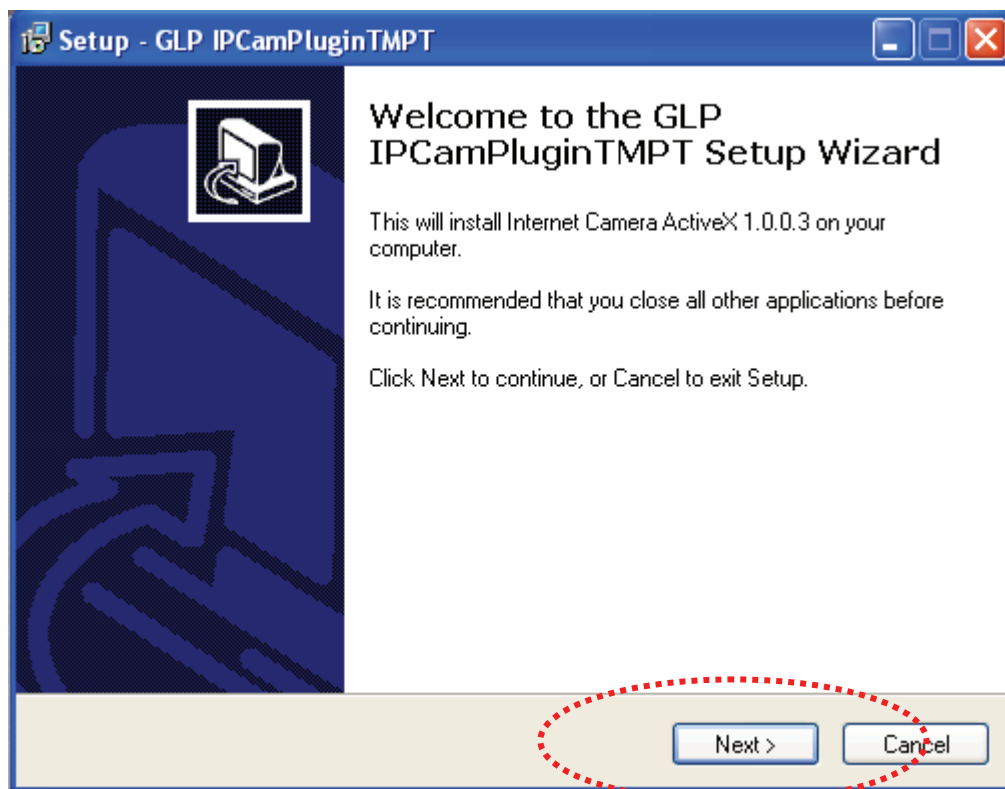

Click 'Finish' to complete plugin installation.

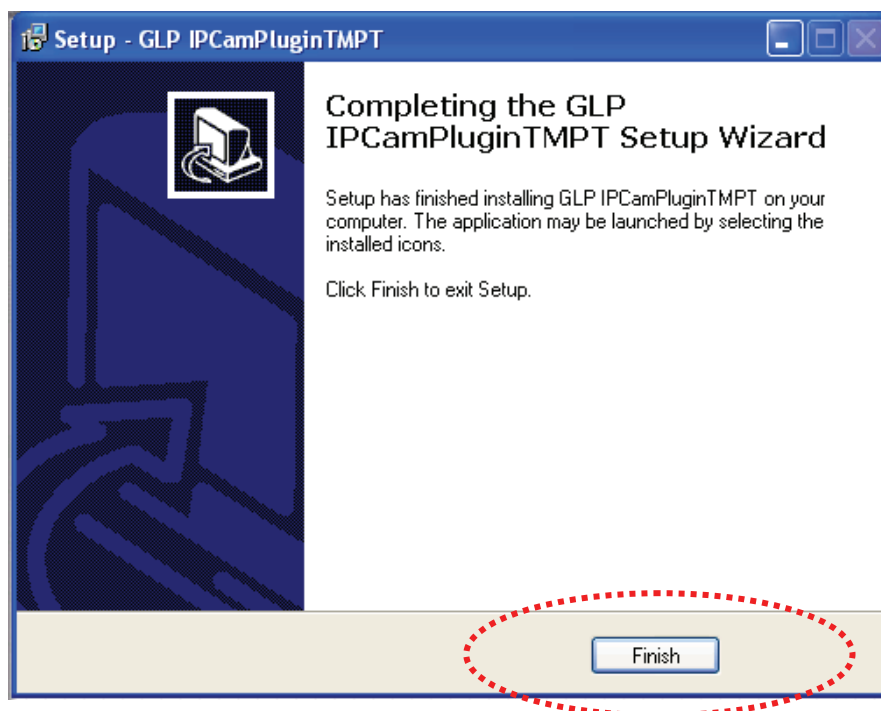

Now you can go back to web browser, and you should be able to see the image captured by camera (You may need to press F5 or CTRL-R to reload web page).

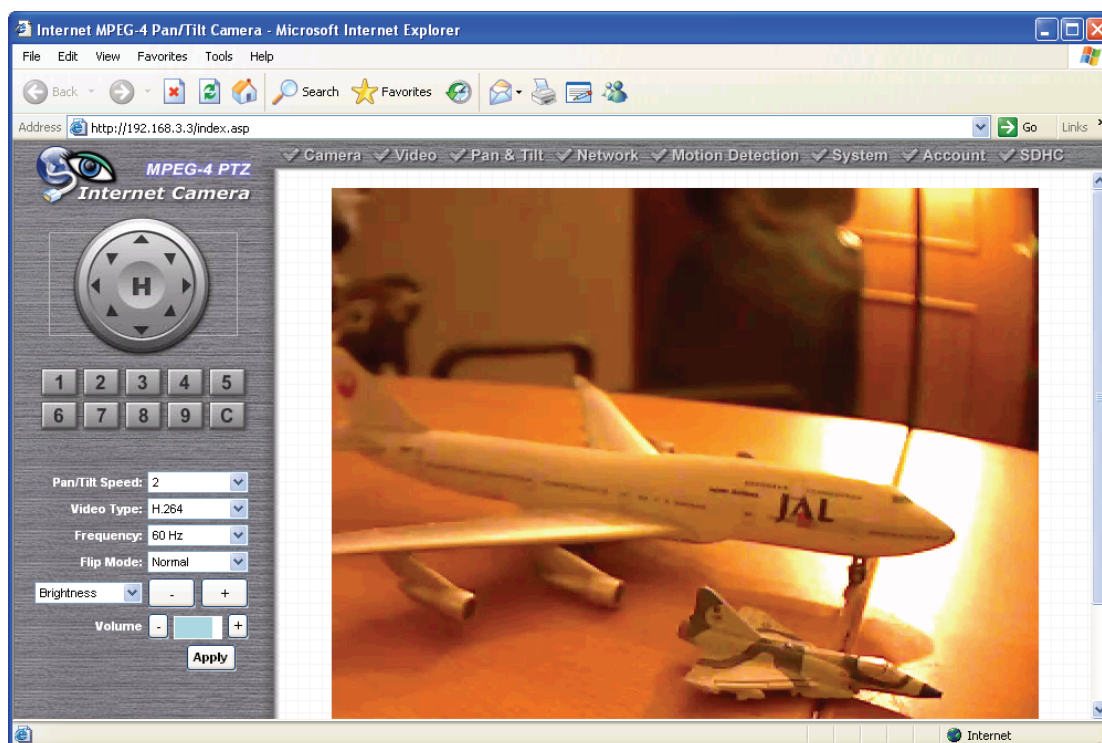

Note: If you see one of these messages (or both):

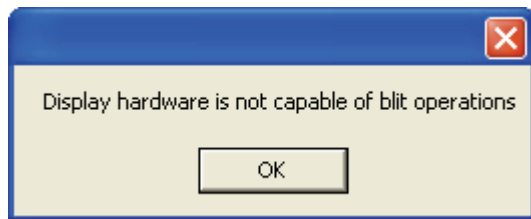

OR

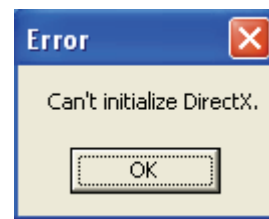

Your computer may not have the display capability that this IP camera requires, or you don't have Microsoft DirectX® installed. Please download Microsoft DirectX® from Microsoft's website (<http://www.microsoft.com>), and try again.

In some cases, your computer is able to display the image from IP camera correctly, but you'll still see these messages. If this happens, just ignore them.

Special notes:

*Because this IP camera has IR coating on its lens, plants will appear as white because of photosynthesis effect, **THIS IS NOT MALFUNCTION.***

Plants seen by human's naked eyes:

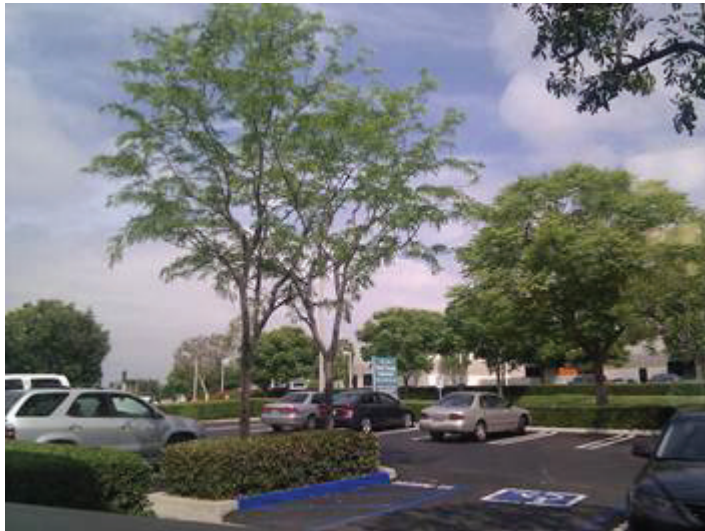

Plants seen through this IP camera:



Chapter II: Using Web Management Interface

2.1 Camera Settings

The first menu after you logged onto web management interface is 'Camera', and this is the only menu you can see the real-time image from camera.

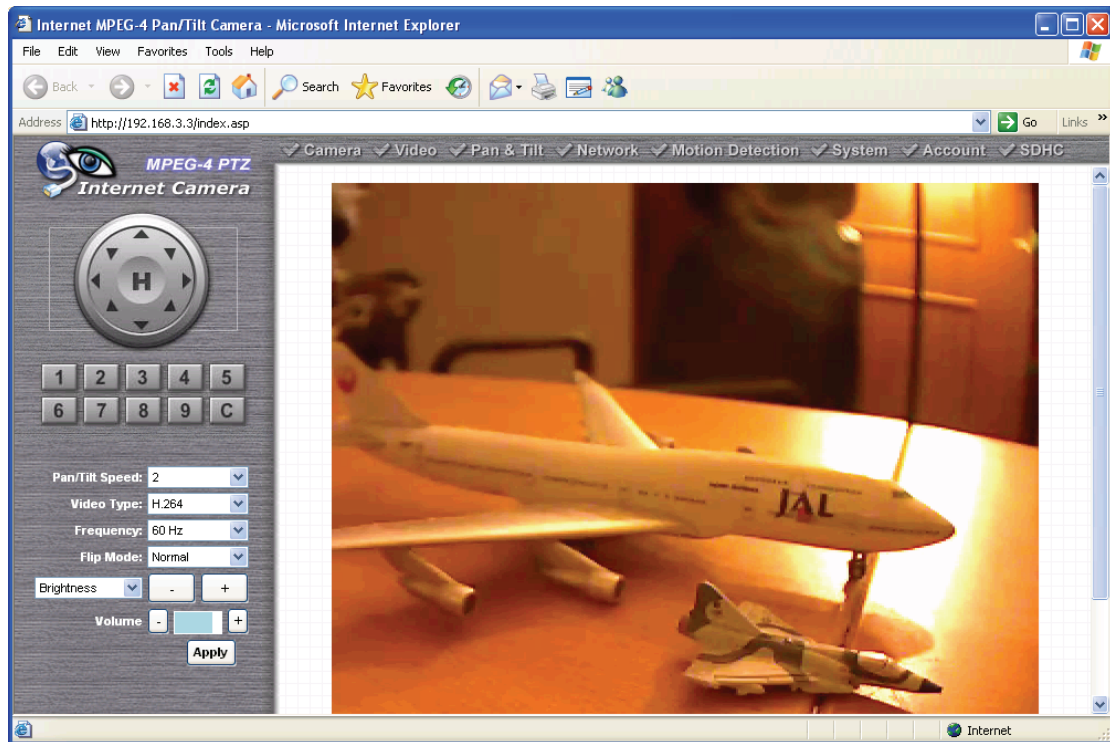



You can always back to this menu by clicking 'Camera' on the top of web management interface.



The descriptions of every setting in this menu will be given below:

Item	Description
Pan/Tilt Speed	Specifies the moving speed when you use pan / tilt function to point the camera to a new direction. Available options are 1 (fastest) to 5 (slowest). Select 1 to move the camera by a faster speed, but you will not be able to control the movement precisely. If you want to move the camera in a more accurate manner, select a slower speed.
Video Type	Specifies video encoding type. Available options are 'MPEG4', 'MJPEG', and 'H.264'. Different encoding type requires different bandwidth, and provides different video quality.
Frequency	If the place where this IP camera points to has a (or more) fluorescent light(s), the image may look flashing. In this case, you can adjust this setting to the frequency of electrical power; this can improve the image quality effectively. If you don't know which one you should use, just try any of them and select one with less flicker.
Flip Mode	If you're not putting this camera on a horizontal surface but hang the camera on the ceiling or wall, you can use this function to rotate the displaying image.
Brightness / Saturation / Sharpness	Select brightness, saturation, and sharpness from dropdown menu, and click ' - ' or ' + ' button to increase or decrease brightness / saturation / sharpness setting value. In certain environment, adjust brightness, saturation, and / or sharpness will help improve video quality.
Volume	Adjust the volume of audio output. Press ' + ' or ' - ' button to increase or decrease volume.
<p><i>NOTE: When you change any setting(s) listed above, please click 'Apply' button so the change(s) will take effect. For following functions, changes will take effect right away.</i></p>	

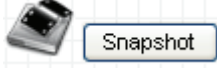
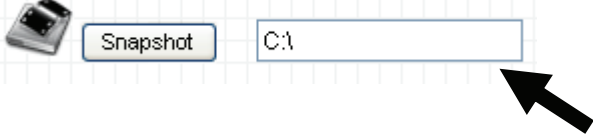
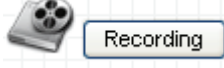
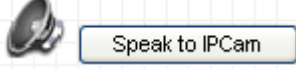
<p>Pan / Tilt Control</p> 	<p>Moves camera to a new direction. Press one of 8 directional buttons to move the camera, and press 'H' to move the camera back to 'home' (original) position.</p>
<p>Preset Points</p> 	<p>You can set up to 9 preset points of camera position; press the number to move the camera to preset point instantly. See next chapter for detail instructions of how to set preset points.</p> <p>Press 'C' and the camera will cruise between all preset points automatically.</p>
<p>Snapshot</p> 	<p>Click 'Snapshot' button to save the displaying image as an image file, a message box will appear after you click 'Snapshot' button, showing the filename and location of saved image file (default filename is current date and time).</p> <p>Default directory used to save image file is 'C:\', you can change the directory by clicking the text input box located at the right of 'Snapshot' button:</p>  <p>and you'll be prompted to select a new directory.</p>
<p>Recording</p> 	<p>Press this button to record the displaying image as a video file in AVI format, and you can play the video file back by Windows Media Player. To stop recording, press 'Stop Recording' button (the same button). You can also change the directory used to save video file.</p>
<p>Speak to IP Cam</p> 	<p>You can transmit the voice received by your computer's microphone to the camera's external speaker. Press and hold this button, then speak to the microphone. Please note that external speaker must be connected to this camera.</p>
<p>Digital Zoom</p>	<p>If you wish to enlarge certain portion of the captured</p>

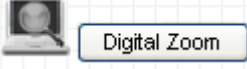
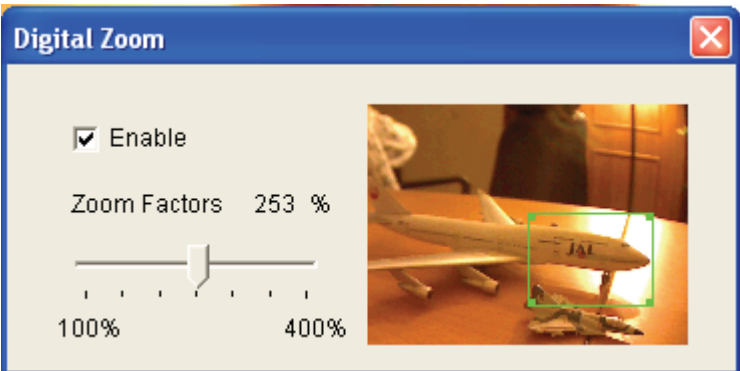
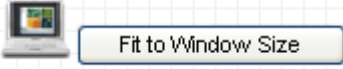
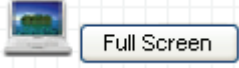
	<p>image, you can click this button to set digital zoom:</p>  <p>Click 'Enable' to enable digital zoom function, then you can drag the slide bar to adjust zoom ratio. You can also use your mouse to drag the zoom area (the green square) to reposition the zoom area.</p>
<p>Fit to Window Size</p> 	<p>Click this button and the image size will be adjusted to fit the size of browser window.</p>
<p>Full Screen</p> 	<p>Click this button to display the image in full-screen mode (uses all available space to display the image captured by this camera).</p>

2.2 Video

You can change video-related settings of this IP camera in 'Video' menu. You can access this menu by clicking 'Video' on the top of web management interface.



There are 5 types of video settings for this IP camera. To set the option of a certain video setting, put mouse cursor on it and its options will appear.

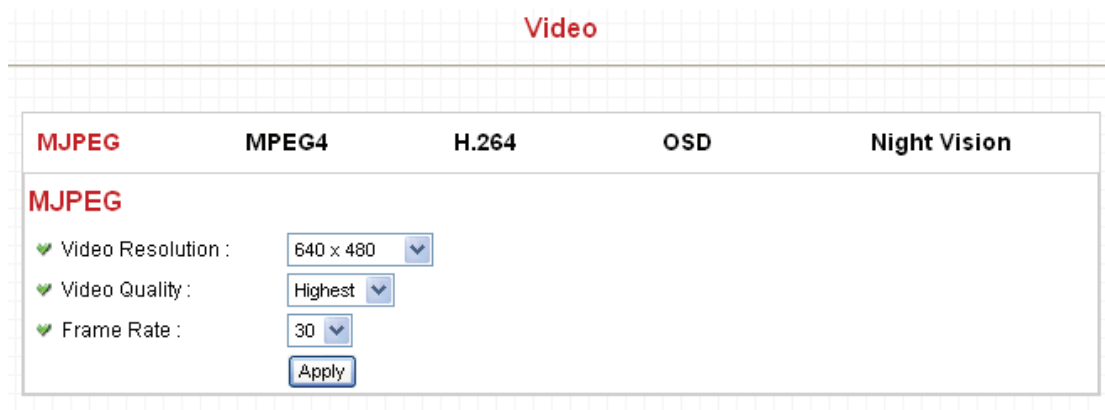

2.2.1 MJPEG

You can adjust video settings when you select 'MJPEG' as video type in 'Camera' menu.

MJPEG

✔ Video Resolution :

✔ Video Quality :

✔ Frame Rate :

The descriptions of every setting in this menu will be given below:

Item	Description
Video Resolution	Changes the resolution of video. Available options are 1280 x 1024, 640 x 480, and 320 x 240. Higher resolution provides better video quality and more detail, but requires more network bandwidth.
Video Quality	Changes video quality. There are 5 levels of video quality from 'Lowest' to 'Highest'. Selecting a higher video quality will provide better video quality, but requires more network bandwidth.
Frame Rate	Changes video frame rate. Available options from '30' to '1', indicates how many video frames this camera will transmit every second. Higher frame rate provides smooth video watching experience and will not lose details of video, but requires more network bandwidth. If you're using this video camera with insufficient network bandwidth, selecting a lower frame rate setting will help.

Click 'Apply' for settings to take effect.

2.2.2 MPEG4

You can adjust video settings when you select 'MPEG4' as video type in 'Camera' menu.

MPEG4

✔ Video Resolution : ▼

✔ Video Quality : ▼

✔ Frame Rate : ▼

The descriptions of every setting in this menu will be given below:

Item	Description
Video Resolution	Changes the resolution of video. Available options are 1024 x 768, 640 x 480, and 320 x 240. Higher resolution provides better video quality and more detail, but requires more network bandwidth.
Video Quality	Changes video quality. There are 5 levels of video quality from 'Lowest' to 'Highest'. Selecting a higher video quality will provide better video quality, but requires more network bandwidth.
Frame Rate	Changes video frame rate. Available options from '30' to '1', indicates how many video frames this camera will transmit every second. Higher frame rate provides smooth video watching experience and will not lose details of video, but requires more network bandwidth. If you're using this video camera with insufficient network bandwidth, selecting a lower frame rate setting will help.

Click 'Apply' for settings to take effect.

2.2.3 H.264

You can adjust video settings when you select 'H.264' as video type in 'Camera' menu.

H.264

✔ Video Resolution :

✔ Video Quality :

✔ Frame Rate :

The descriptions of every setting in this menu will be given below:

Item	Description
Video Resolution	Changes the resolution of video. Available options are 1280 x 1024, 640 x 480, and 320 x 240. Higher resolution provides better video quality and more detail, but requires more network bandwidth.
Video Quality	Changes video quality. There are 5 levels of video quality from 'Lowest' to 'Highest'. Selecting a higher video quality will provide better video quality, but requires more network bandwidth.
Frame Rate	Changes video frame rate. Available options from '30' to '1', indicates how many video frames this camera will transmit every second. Higher frame rate provides smooth video watching experience and will not lose details of video, but requires more network bandwidth. If you're using this video camera with insufficient network bandwidth, selecting a lower frame rate setting will help.

Click 'Apply' for settings to take effect.

2.2.4 OSD

If you need to display information about this camera, like camera's name or current date / time, you can use OSD (On-Screen Display) menu:

On-Screen Display

✔ On-Screen Display : Enable Disable

✔ Show Camera Name : Enable Disable

✔ Show Date : Enable Disable

✔ Show Time : Enable Disable

The descriptions of every setting in this menu will be given below:

Item	Description
On-Screen Display	Select 'Enable' to enable on-screen display function (information about this camera will be displayed on camera's display image), and select 'Disable' to disable it.
Show Camera Name	Select 'Enable' to show camera's name on camera's display image, select 'Disable' to hide it.
Show Date	Select 'Enable' to show current date on camera's display image, select 'Disable' to hide it.
Show Time	Select 'Enable' to show current time on camera's display image, select 'Disable' to hide it.

Click 'Apply' for settings to take effect.

When OSD is enabled, selected OSD items will be displayed like this:

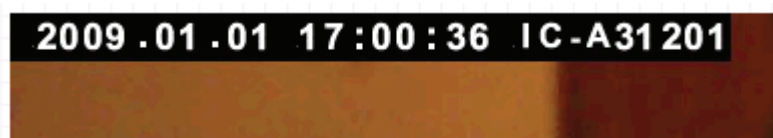

2.2.5 Night Vision

This camera equips with 9 IR LEDs to enhance video quality in the night. You can enable or disable IR LEDs by 'Night Vision' menu:

IR Control

- Always turn off IR led
- Always turn on IR led
- Auto mode
- Turn on/off IR led by schedule

✔ Turn on IR led from :

: 24-hour (hh : mm)

✔ Turn off IR led from :

: 24-hour (hh : mm)

The descriptions of every setting in this menu will be given below:

Item	Description
Always** turn off IR led	Do not use IR LEDs, even it's very dark.
Always** turn on IR led	Turn IR LEDs on, even it's very bright.
Auto mode	Let camera decide to switch LED lights on or off automatically: LEDs will light up when it's too dark. If you don't know which option you should select in this page, select this one.
Turn on/off IR led by schedule	Switch IR LEDs on or off by schedule. You have to input start time in 'Turn on IR led from' section, and end time in 'Turn off IR led from' section.

Click 'Apply' for settings to take effect.

2.3 Pan and Tilt

This IP camera supports pan and tilt function, as you explored in last section. You can also make the camera move automatically in pan and tilt menu by defining a set of pre-defined path.

You can access this menu by clicking 'PTZ' on the top of web management interface.



2.3.1 Preset Points

You can define the camera position and save the position so you can recall the position later again. This camera provides 9 memory slots; follow the following instructions to move the camera and set a new preset point:

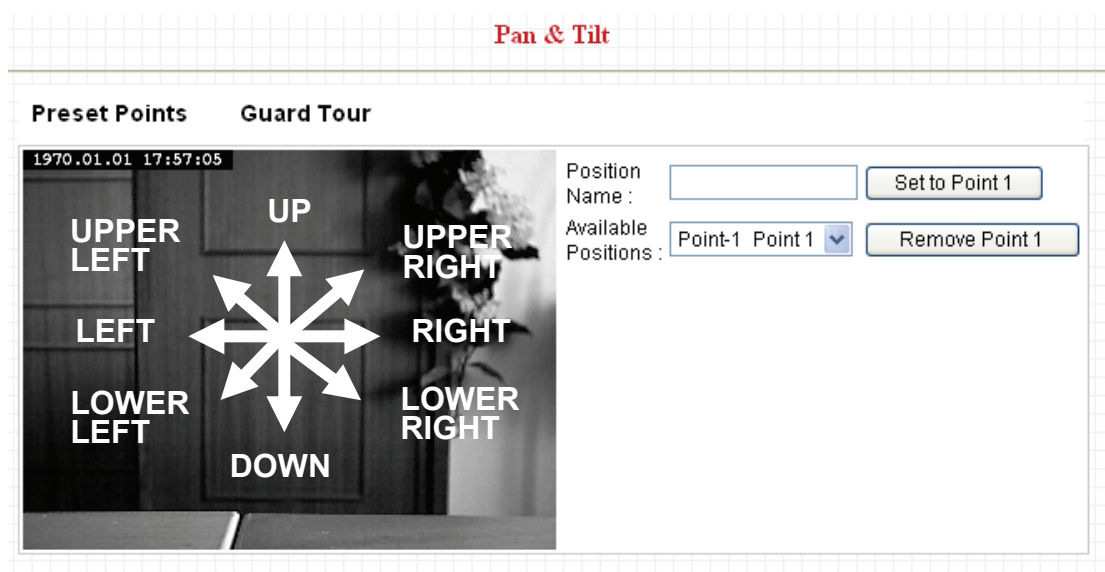

1. Select a memory slot from 'Available Positions' dropdown menu first.
2. To move the camera, click the position of labeled text (not shown on image) on the image to move the camera to the direction. You may need to set the Pan / Tilt speed to a slower setting, so you can move the camera in a more accurate manner.

3. When you move the camera to the position you want, type a name in 'Position name' field, and click 'Set to Point n ' (where 'n' is the number of memory slot) button to save the position to selected memory slot.

After you set the position, you can recall the position from 'Camera' menu (click the position number button), and the camera will move to preset position instantly.

If you want to remove a preset position, select the memory slot from 'Available Positions' dropdown menu, and then click 'Remove Point n ', (where 'n' is the number of memory slot you wish to clear position setting).

2.3.2 Grand Tour

You can make the camera move between many pre-defined positions, and define the time you wish to pause at every position; this is called as 'Grand Tour'.

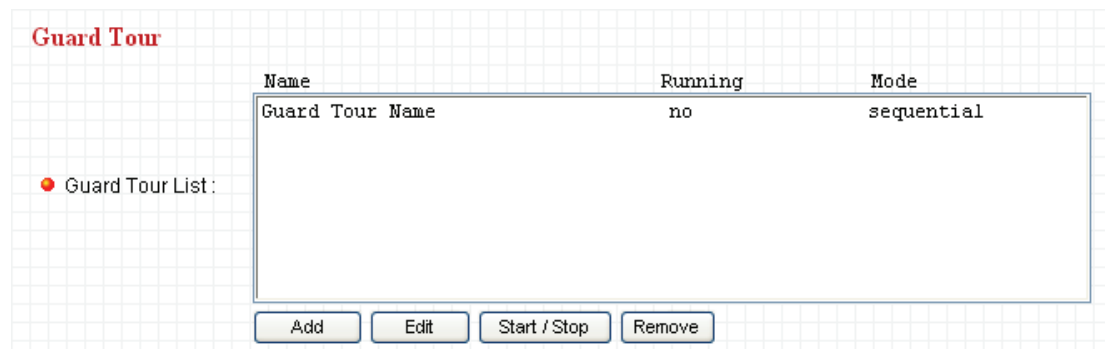

Before you can use this function, you have to define at least 2 positions in 'Preset Points' section (refer to last section for detailed information).

The descriptions of every setting in this menu will be given below:

Item	Description
Add	Add a new set of grand tour (see instructions below)
Edit	Edit a selected grand tour. The parameters for an existing grand tour will be recalled and you can modify them.
Start / Stop	Select a grand tour and click this button to start grand tour, click again to stop it. After a grand tour has been started, go to 'Camera' menu to see it in action. Only one grand tour can be activated at the same time.
Remove	Remove a grand tour from the list.

If you wish to add a new set of grand tour, click 'Add' to start to add a new grand tour set:

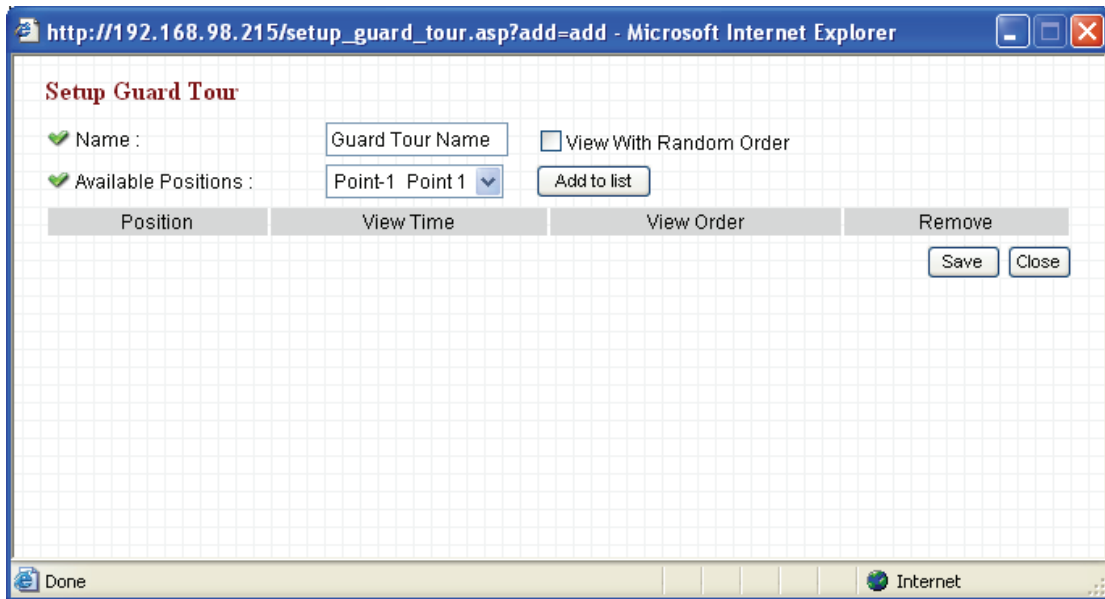

The descriptions of every setting in this menu will be given below:

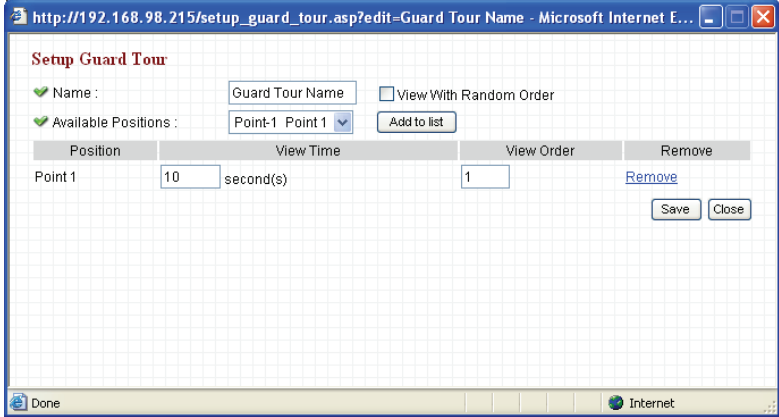
Item	Description
Name	Input the name of this set of grand tour here. As you may have many sets of grand tour, please give it a meaningful name so you can remember the main purpose of this set.
View with random order	Do not visit all positions in this grand tour by order; visit them randomly instead.
Available positions	<p>Select preset points from dropdown menu here, then click 'Add to list' to add this position to this grand tour.</p> <p>When you click 'Add to list', you'll be prompted to set these parameters:</p>  <p><i>View Time: Define the time you wish the camera to stop at this position in seconds.</i></p> <p><i>View Order: Give this position a number greater than 1 and not the same with other positions, and grand tour will start visiting positions by order (from 1 to last number, and then start from 1 again).</i></p> <p><i>Remove: Remove this position from list.</i></p> <p><i>Save: Save settings for this position.</i></p> <p><i>Close: Close this window and discard all changes.</i></p>

2.4 Network Settings

All network-related settings can be found in this menu, and you have to specify TCP/IP parameters in this menu if you want to change IP address, use PPPoE, Dynamic DNS, and activate UPnP function.

You can access this menu by clicking 'LAN' on the top of web management interface.



After you selected 'Network', network setting menu will appear. There are 6 sub-menus available here:

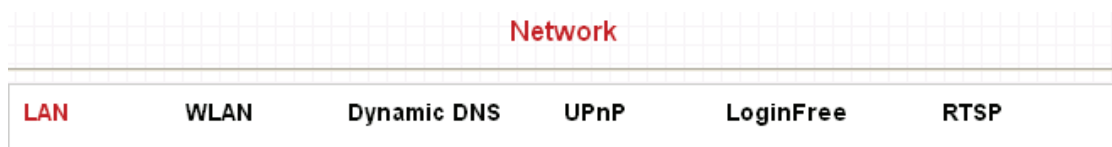

Please click the network setting you wish to set, and then refer to instructions given below:

2.4.1 LAN

You can define IP address and select the port number you wish to use here.

LAN

- ♥ Network Type : DHCP Static IP Address
- ♥ IP Address :
- ♥ Subnet Mask :
- ♥ Gateway :
- ♥ Primary DNS :
- ♥ Secondary DNS :
- ♥ Web Port :

PPPoE

- ♥ Enable PPPoE : Enable Disable
 - ♥ User Name :
 - ♥ Password :
 - ♥ MTU : (512<=MTU Value<=1492)
-

The descriptions of every setting in this menu will be given below:

Item	Description
Network Type	<p>This camera can obtain the IP address from DHCP server automatically (if you have one), or set a fixed IP address. Select 'DHCP' to obtain IP address automatically or 'Static IP Address' to assign this IP camera with a fixed IP address.</p> <p>When 'DHCP' is selected, IP address parameters below will be grayed out.</p>
IP Address	Specify the IP address for this IP camera here.
Subnet Mask	Specify the subnet mask for this IP camera here.
Gateway	Specify the gateway address of the local network here.
Primary DNS	Specify the IP address of DNS server here. Please input IP address only. If you don't know the address of DNS server, ask network administrator or your ISP for help.
Secondary DNS	<p>Specify the IP address of backup DNS server here. When primary DNS is unreachable, IP camera will use the IP address specified here as DNS server.</p> <p>This field is optional.</p>
Web Port	<p>Specify the port number of web management interface here. If it's not 80, you'll have to add ':port' after the IP address / hostname of this IP camera.</p> <p>For example, if the HTTP port number you specified here is 90 and the IP address of IP camera is 10.20.20.30, then you have to input '<i>http://10.20.20.30:90</i>' in the address bar of Internet explorer.</p>
Enable PPPoE	Select 'Enable' to activate PPPoE function of this IP camera, select 'Disable' to disable it.
User Name	Input the PPPoE username assigned by your ISP here.
Password	Input the PPPoE password assigned by your ISP here.
MTU	Input the MTU (Maximum Transmission Unit) given by your ISP here. Ask your ISP if you don't know what value you should input here. Default value should work with most of ISPs and will give you a nice network performance.

Click 'Apply' to save settings and make the new settings take effect.

2.4.2 WLAN

Wireless LAN

Wireless Connection : Enable Disable

Network Type : Infrastructure

Available Networks : Refresh

Connect	SSID	MAC Address	Signal	Channel	Encryption	Network Type
<input checked="" type="radio"/>		00:07:40:FE:60:7E		4	WPAPSK(TKIP)	Infrastructure
<input type="radio"/>	books	00:1B:11:62:84:68		8	WPA2PSK(AES)	Infrastructure

SSID :

Channel : 1

Wireless Key :

Apply

WPS

Self PinCode : 31500203

Configure via Push Button : Start PBC

Configure via PinCode : Registrar SSID : Start PIN

The descriptions of every setting in this menu will be given below:

Item	Description
Wireless Connection	Select 'Enable' to activate wireless network function of this IP camera, select 'Disable' to disable it.
Network Type	Select the network type of wireless connection. Available options are 'Infrastructure' (Connect the IP camera to a wireless access point), and 'Adhoc' (This IP camera will become a stand-alone wireless network point, other wireless computers / devices can discover this IP camera and connect to it without wireless access point).

	<p>You can set to 'Adhoc' when you don't have any wireless access point, but your computer has wireless network card. Set to 'Infrastructure' when you have wireless access point, and you have computers with wired network connection.</p>
<p>Available Networks</p>	<p>Here shows all wireless access points found by this IP camera. Please note not all access points will be displayed at the same time, if the access point you expected to connect does not appear, you may have to click 'Refresh' button for several times until it appears.</p> <p>The descriptions of all fields is listed below:</p> <p>Connect: You can select the wireless access point you wish to connect here.</p> <p>SSID: the SSID of all found wireless access points will be shown here. Some wireless access point may hide their SSID; in this case, you have to identify them by their MAC address.</p> <p>MAC Address: If you there are many wireless access points in proximity or some wireless access point hides it's SSID, you can use MAC address to distinguish them.</p> <p>Signal: Shows the radio signal strength in percent.</p> <p>Channel: Shows the radio channel of this wireless access point.</p> <p>Encryption: Shows the encryption type used by this wireless access point. You must use the same encryption type if you wish to connect to a certain wireless access point. If the wireless access point does not use encryption, 'Disabled' will be displayed here.</p> <p>Network Type: Shows the network type of a certain wireless access point (Infrastructure or Adhoc).</p>

SSID	<p>Input the SSID of the wireless access point you wish to connect. It should be less than 32 alphanumerical characters.</p> <p>When you select a wireless access point above, it's SSID will be filled in this field automatically. However, if the SSID is not displayed (the wireless access point you selected choose to hide it's SSID), you have to know it's SSID and input it here, or you will not be able to connect it.</p>
Channel	<p>Select the radio channel you wish to use here. When network type is 'Infrastructure', the radio channel is auto-selected according to the channel that wireless access point uses. You can only select the channel number when network type is 'Adhoc'.</p>
Wireless Key	<p>Input the encryption key of selected wireless access point here. This is required when access point you wish to connect uses encryption.</p>
Self PinCode	<p>Here displays the WPS pin code used to connect to WPS-enabled wireless access points. You have to input this number into the WPS enabled access point to establish WPS connection.</p>
Configure via Push Button	<p>Click this button and this camera will enter PBC-style WPS connection state for 120 seconds. Please push 'Start PBC' button on the wireless access point you wish to connect within 120 seconds to establish WPS connection (The remaining time will be displayed on the button).</p> <p>If connection can not be established after 120 seconds, you'll be prompted by a message box, and you can press 'Start PBC' button to try again.</p>
Configure via PinCode	<p>If you have wireless access point's WPS PIN code, you can input it here and press 'Start PIN' button to start to establish PIN-style WPS connection.</p>

2.4.3 Dynamic DNS

If your ISP does not give you a fixed Internet IP address (i.e. the Internet address you're using when you access the Internet is not always the same – ask your ISP for detailed information), you can use this function to help you locate the IP address of this IP camera when you're away from home or office.

Before you can use this function, you'll need to apply for an account at dyndns.org (<http://www.dyndns.org>). Detailed instructions of how to apply a new account can be found on dyndns.org's website.

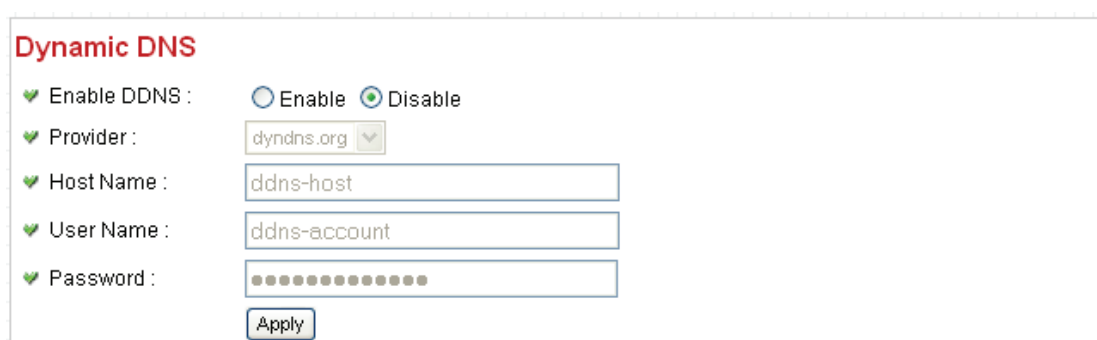

Dynamic DNS

♥ Enable DDNS : Enable Disable

♥ Provider :

♥ Host Name :

♥ User Name :

♥ Password :

The descriptions of every setting in this menu will be given below:

Item	Description
Enable DDNS	Select 'Enable' to activate Dynamic DNS function of this IP camera, select 'Disable' to disable it.
Provider	Select dynamic DNS service provider here. Only dyndns.org is available currently.
Host Name	Input dynamic DNS host name here.
User Name	Input dynamic DNS user name here, must be the same as the one you applied on dyndns.org.
Password	Input dynamic DNS password here, must be the same as the one you applied on dyndns.org.

Click 'Apply' to save settings and make the new settings take effect.

2.4.4 UPnP

When UPnP function is activated, all UPnP-compatible computers / network devices will be able to discover this IP camera automatically (only those in the same local network).

This function is useful and you don't have to remember the IP address of this IP camera. Simply open 'Network neighbor' and it's there!



The descriptions of every setting in this menu will be given below:

Item	Description
Enable UPnP	Select 'Enable' to activate UPnP function of this IP camera, select 'Disable' to disable it.

Click 'Apply' to save settings and make the new settings take effect.

After UPnP function is activated, a popup message will appear:

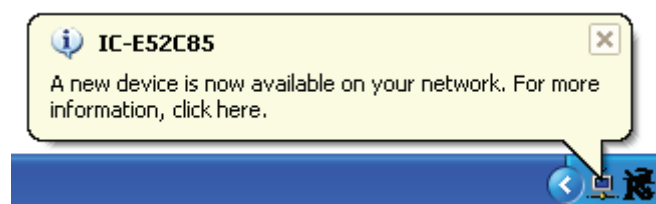

Click the message to open 'My Network Places', and you'll see the IP camera:

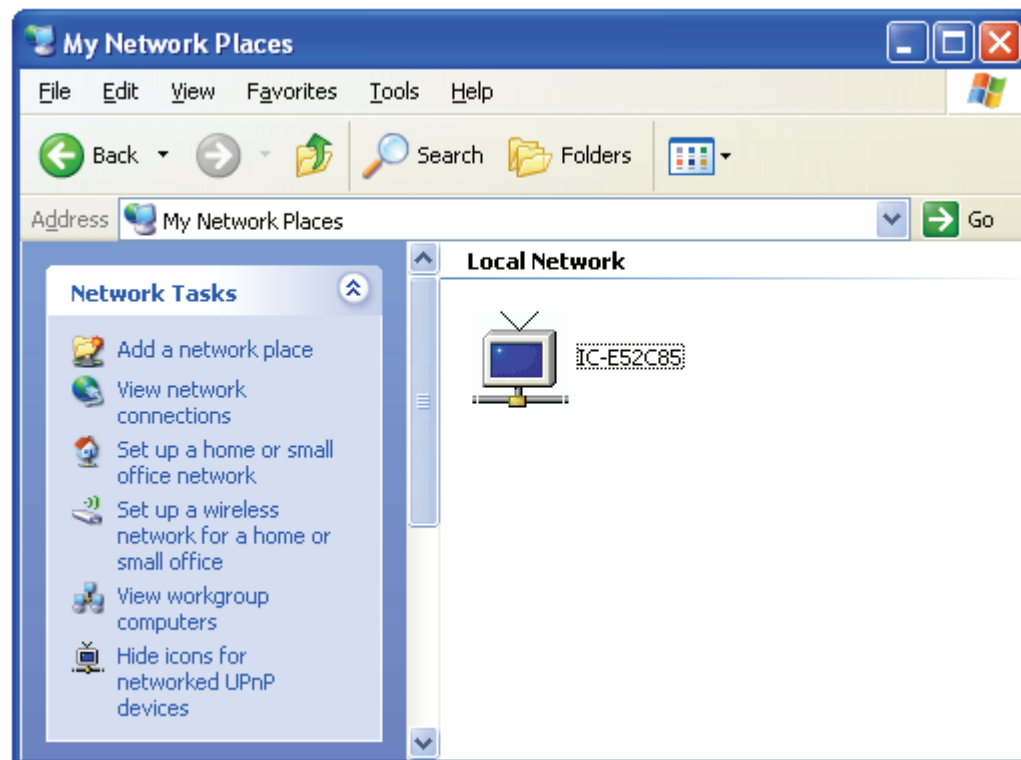

You can double-click the icon to launch Internet Explorer and log onto IP camera's web management interface directly.

2.4.5 LoginFree

This camera provides a method to let unauthorized users to view the image captured by this camera, which is called as 'LoginFree'. When you wish to let everyone to view the image captured by this camera, or integrate the image with your own web application, you can use this function:

LoginFree

♥ Filename : .jpg

Input the filename here, and click 'Apply' to save settings, then other users can access the image by this filename with .jpg extension with the camera's IP address as prefix. For example, if your camera's IP address is '192.168.2.1' and the filename you set here is 'picture', then everyone on the web can access the image captured by this camera by using the following address:

<http://192.168.2.1/picture.jpg>

Please note that no authentication will be required to see the captured image. If you wish to disable this function, clear the text in 'Filename' field and click 'Apply'.

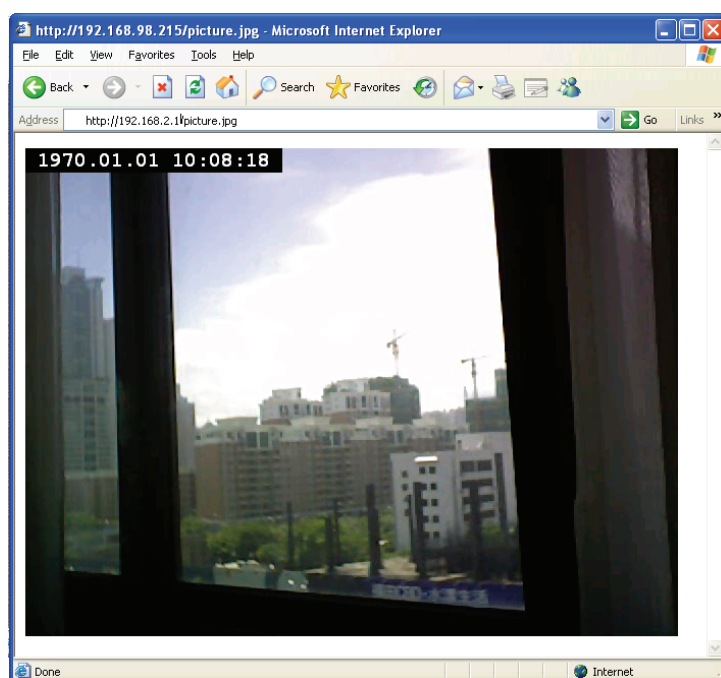

2.4.6 RTSP

If you want to watch video captured by this IP camera by your own RTSP (Real Time Streaming Protocol) media player, you can use this function to setup RTSP parameters, so your RTSP-compatible player will be able to receive video data.

Video Streaming

♥ RTSP Port :

♥ MPEG4 RTSP Path : .sdp

♥ H264 RTSP Path : .sdp

♥ RTP Port Range : -

The descriptions of every setting in this menu will be given below:

Item	Description
RTSP Port	Input the port number of RTSP here. Default setting is 554.
MPEG4 RTSP Path	Input the path of MPEG4 RTSP video file. When you use RTSP-compatible media player to play RTSP stream, please remember to add '.sdp' file extension.
H.264 RTSP Path	Input the path of H.264 RTSP video file. When you use RTSP-compatible media player to play RTSP stream, please remember to add '.sdp' file extension.

2.5 Motion Detection

When you wish to use this camera to monitor the activities, motion detection function will be very useful. Camera will detect the motion in captured image, and take a snapshot when motion is detected. So you can use this camera to keep the safety of the belongings you have.

To use motion detection, click the following link from the top of menu:



After you selected 'Motion Detection', a sub-menu will appear. There are 5 sub-menus available here:



Detailed descriptions of every setting will be given below.

2.5.1 Motion Detection

You can use this menu to setup basic motion detection settings:

Motion Detection

- ✔ Enable Motion Detection : Enable Disable
- ✔ Motion Detection Interval : 5 seconds
- ✔ Recording Time : 3
- ✔ Sending File Type : JPEG
- ✔ Send snapshot file to FTP : Enable Disable
- ✔ Send snapshot file to E-Mail : Enable Disable

SD Card

- ✔ SD Card Record : Enable Disable
- ✔ Storage File Type : JPEG
- ✔ Record File Size : 10 MBytes (Max 100 MB)

Samba Network

- ✔ Record to Folder : Enable Disable
 - ✔ Authentication : Anonymous
 - ✔ User Name :
 - ✔ Password :
 - ✔ Samba Server : 192.168.3.61
 - ✔ Shared Folder : share
 - ✔ Storage File Type : JPEG
 - ✔ Record File Size : 10 MBytes (Max 100 MB)
-

The descriptions of every setting in this menu will be given below:

Item	Description
Enable Motion Detection	Select 'Enable' to enable motion detection, and select 'Disable' to disable this function.
Motion Detection Interval	Select the time interval between two motions from dropdown menu. When a motion is detected, camera will not detect any motion again within the time interval you specified here. Available options are from 0 second (always detect new motion) to 60 seconds.

Recording Time	Select the duration you wish this camera to record image when a motion is detected from dropdown menu. Available options are 1, 2, 3, 4, and 5 (seconds).
Sending File Type	Select the file type that will be saved when a motion is detected. Select 'JPEG' and a still picture in JPEG format will be saved; and select 'AVI' to save a motion video clip.
Send snapshot file to FTP	Select 'Enable' to send the saved file to appointed FTP server when a motion is detected, select 'Disable' to disable this function. You have to configure FTP server parameters in 'FTP Configuration' menu first, so this function will take effect (see below).
Send snapshot file to E-Mail	Select 'Enable' to send the saved file to appointed E-mail address when a motion is detected, select 'Disable' to disable this function. You have to configure mail server parameters in 'FTP Configuration' menu first, so this function will take effect (see below).
SD Card Record	Select 'Enable' to record detected motion to SD card (if there's one), and select 'Disable' to disable this function.
Storage File Type	Select saving file type for motion detection: JPEG (still picture) or AVI MPEG4 / AVI H264 (for motion picture).
Record File Size	Input the maximum file size of saved file in Mbytes. Maximum file size is 100.
Record to Folder	Select 'Enable' to save file to a network folder which supports SAMBA (also known as 'Windows Network Neighborhood'), select 'Disable' to disable this function.
Authentication	If username and password are not required to write files in specified folder, select 'Anonymous'; if required, select 'Account'.
User Name	Input user name required by destination network folder.
Password	Input password of the user name required by destination network folder.
Samba Server	Input the IP address or host name of network file server.
Shared Folder	Input the folder name on file server.
Storage File Type	Select saving file type for motion detection: JPEG (still picture) or AVI MPEG4 / AVI H264 (for motion picture).
Record File Size	Input the maximum file size of saved file in Mbytes. Maximum file size is 100.

Click 'Apply' to save settings and make the new settings take effect.

2.5.2 Motion Region

You can define the motion detection region within the image that camera captures, so this camera will ignore motions which are not covered by the motion region setting, and reduce the chances of false alarm.



The descriptions of every setting in this menu will be given below:

Item	Description
Region 1 – 3	Check the box to enable motion detection region 1 to 3. You can check multiple boxes to enable multiple motion detection regions. When you checked a box, a new region (and region number) will be displayed on captured image.

Sensitivity	Move the slide bar to change the motion detection sensitivity setting: Drag the slide to the right to increase sensitivity (camera will detect minor changes in the image), and drag the slide to the left to decrease sensitivity (camera will only detect major changes in the image).
Refresh	In case the objects of the image captured by the camera moved, click this button to reload the image captured by camera, so you can decide the motion detection region more precisely.
Save	Save motion detection region settings.

To change the motion detection region, you can 'resize' and 'reposition' it:



Move the mouse cursor to the eight dots located at the border of motion detection region, and the mouse cursor will switch to \leftrightarrow , \nwarrow , or \updownarrow . You can click and hold mouse button and move the mouse to resize the motion detection region.

To move reposition the motion detection region, move the mouse within the motion detection region, and the mouse cursor will switch to $\blacktriangleleft\blacktriangleright$. Click and hold mouse button and move the mouse to reposition the motion detection region.

2.4.3 Email

You can define the destination address of E-mail sending and mail server parameters here.

E-Mail

♥ Recipient E-Mail Address :

♥ E-Mail Subject :

♥ SMTP Server :

♥ Sender E-Mail Address :

♥ SMTP Authentication : Enable Disable

♥ User Name :

♥ Password :

The descriptions of every setting in this menu will be given below:

Item	Description
Recipient E-Mail Address	Input the email recipient's Email address here.
E-Mail Subject	Specify the title of sending email, so you can identify the mail sent from this camera from others quickly.
SMTP Server	<p>Input the IP address or host name of the SMTP server (the server that delivers the Email for you) here.</p> <p>If you don't know, please refer to the SMTP server you're using in your Email software (like Outlook, Outlook Express etc.), or ask your network administrator or ISP.</p>
Sender E-Mail Address	<p>Input the Email address of mail sender, this will help you to identify the Email sent by this IP camera by sender's Email address.</p> <p><i>NOTE: Some mail server would reject to deliver the Email from unknown sender, it's recommended to input your own Email address here, or any other actual one.</i></p>
SMTP Authentication	Some SMTP server requires mail senders to be authenticated before they can send Email. If your SMTP server requires you to do so, please select 'Enable', or

	select 'Disable' to disable it. If you don't know, please refer to the SMTP server you're using in your Email software (like Outlook, Outlook Express etc.), or ask your network administrator or ISP.
User Name	Please input the user name of SMTP server here, if your SMTP server requires the use of authentication.
Password	Please input the password of SMTP server here, if your SMTP server requires the use of authentication.

Click 'Apply' to save settings and make the new settings take effect.

After that, you can click 'Send a test email' to send a testing Email to the address you set here, so you can make sure the setting you specified here is correct and working.

2.4.4 FTP Configuration

You can set FTP server's parameters here.

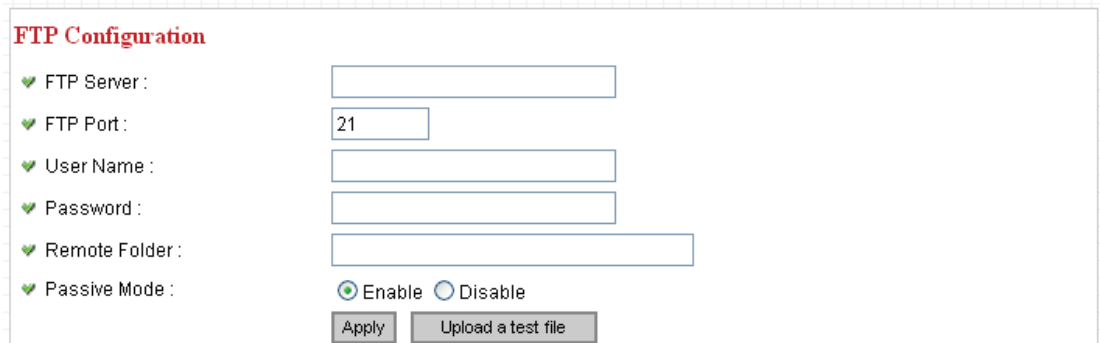

FTP Configuration

♥ FTP Server :

♥ FTP Port :

♥ User Name :

♥ Password :

♥ Remote Folder :

♥ Passive Mode : Enable Disable

The descriptions of every setting in this menu will be given below:

Item	Description
FTP Server	Input the IP address or host name of the FTP server you wish to use here.
FTP Port	Input the port number of the FTP server you wish to use here.
User Name	Input the user name of the FTP server you wish to use here.
Password	Input the password of the FTP server you wish to use here.
Remote Folder	Input the remote folder name on the FTP server here. If nothing is specified here, all uploaded image files will be placed in FTP server's root directory. Please ask FTP server's administrator to know which folder you should use. Certain user name may have restrictions and therefore can not place the file in the directory not owned by the user.

Passive Mode	<p>Select 'Enable' to use passive mode to send file, or select 'Disable' to not to use passive mode to send file.</p> <p>Some FTP servers require passive mode, if you don't know, please ask FTP server's administrator; most of FTP servers will work fine with both modes, but if you found that non-passive mode is not working, you can try to use passive mode.</p>
--------------	---

Click 'Apply' to save settings and make the new settings take effect.

After that, you can click 'Upload a test file' to send a file to the FTP server you set here, so you can make sure the setting you specified here is correct and working.

2.4.5 SD Card Configuration

You can define the filename and destination folder when saving a file in SD card.

SD Card Configuration

Enable Cycle Recording

♥ File Name Prefix :

♥ Destination Folder :

The descriptions of every setting in this menu will be given below:

Item	Description
Enable Cycle Recording	Check this box and this camera will automatically erase oldest image file to make rooms for new image files when SD card is full. If you don't want to lose old image files, do not check this box.
File Name Prefix	Specify the filename prefix (the texts which will be added before the file sequence number).
Destination Folder	Specify the folder name that camera will store the saved image or video clip.

Click 'Apply' to save settings and make the new settings take effect.

2.6 System Info

You can use this menu to get the operational information of this camera:



After you selected 'System Info.', a sub-menu will appear. There are 4 sub-menus available here:



Detailed descriptions of every setting will be given below.

2.6.1 Camera Information

Camera information allows you to set the name and administrator's password of this camera.

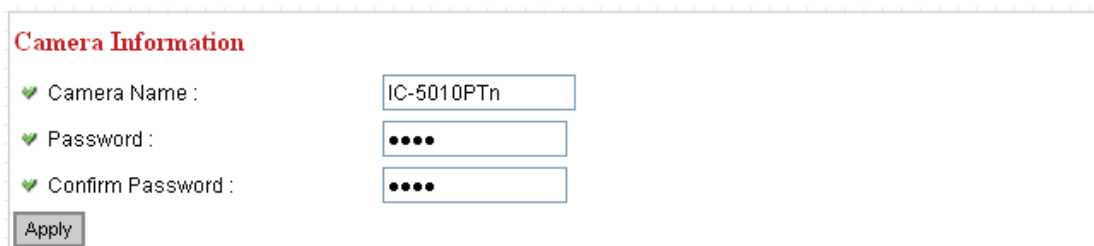

Camera Information

✔ Camera Name : IC-5010PTn

✔ Password : ●●●●

✔ Confirm Password : ●●●●

Apply

The descriptions of every setting in this menu will be given below:

Item	Description
Camera Name	Please specify the name of this IP Camera here. This can be used to identify your camera on the network when you have more than one IP camera in the same network. Default name begins with 'IC-' plus the last 6 characters of the MAC address of this IP camera. You can modify the name to the one you can remember and meaningful to you, but never give all IP cameras in the same network with same name.
Password	Please specify user name 'admin' 's password here. (The one you need when you log onto web management interface and use 'admin' as user name.
Confirm Password	Please input the same password again, to make sure there's no typo.

Click 'Apply' to save settings and make the new settings take effect.

2.6.2 Date / Time Setting

This setting allows you to change the date and time of the real time clock in this IP camera. You can set the time manually, or use network time protocol (NTP) to set the time automatically.

Date / Time Setting

Set Date/Time manually / / : :

NTP Server

✓ Time Zone :

✓ NTP Server :

✓ Daylight Saving Time : Yes No

The descriptions of every setting in this menu will be given below:

Item	Description
Set Date/Time manually / NTP Server	<p>If you select 'Set Date/Time manually', you can set the date and time of this camera manually. Please input the date and time you wish to set here.</p> <p>Date / time format is YYYY / MM / DD HH:MM:SS Time is in 24-hour format.</p> <p>You can click 'Synchronize to PC time' to use the time of the computer you're using.</p> <p><i>Example: 24th August 2007 = 2007/ 08 / 24, and PM 9:24:30 = 21:24:30</i></p> <p>If you select 'NTP Server', the camera will get the date and time from NTP Server automatically.</p>
Time Zone	Please select the time zone of the country / city of resident from dropdown menu here.
NTP Server	Please input the IP address or host name of NTP server here. You can use default value 'pool.ntp.org', or ask your ISP for the IP address or host name, if they have one.
Daylight Saving	If your area of residence uses daylight saving, select

Time	'Yes'; otherwise select 'No'.
Synchronize to PC time	Click to input current time of your computer to 'Set Date / Time manually' field.

Click 'Apply' to save settings and make the new settings take effect.

If you wish to use the date and time setting of the computer which is connecting to the camera, click 'Synchronize to PC time' button. The date and time setting of the computer will be filled to date and time setting in this page.

2.6.3 Utilities

This menu allows you to upgrade firmware, clear all settings, reboot the IP camera, and switch LED lights on/off.

Utilities

✔ Upgrade Firmware :

✔ Reset To Factory Defaults :

✔ Reboot Device :

✔ LED Setting :

The descriptions of every setting in this menu will be given below:

Item	Description
Upgrade Firmware	<p>If you downloaded latest firmware file from our website, you can click 'Browse' button to pick a firmware file located on your computer's hard drive and you can upload the firmware file to the IP camera later.</p> <p>After you selected a proper firmware file from your computer, click 'Upgrade Firmware' button to start upgrade. DO NOT DISCONNECT NOW!</p> <p>If the firmware file you provided is invalid or you didn't provide the firmware file, you'll be prompted to select another valid firmware file again.</p> <p>The IP camera will reboot after the upgrade procedure is done. PLEASE NOTE THAT THE IP ADDRESS OF THE CAMERA WILL RESET TO DEFAULT VALUE: 192.168.2.3</p>
Reset to Factory Defaults	<p>Clear all settings in the camera. Please think again before you do this, and then click this button to reset all settings.</p> <p><i>NOTE: IP address will be reset to default value '192.168.2.3' also. You'll need to change the IP address</i></p>

	<i>setting of your computer if the IP address of your computer does not begin with '192.168.2', and subnet mask is not '255.255.255.0', or you'll not be able to connect to this IP camera again.</i>
Reboot Device	If you found the IP camera is responding slowly or behaves strange, you can click this button to try to reboot the IP camera, this may help.
LED Setting	<p>Click 'Turn off LED light' button to switch the LED light of this IP camera off, so all LEDs on the IP camera will stop working, in case you don't want other people know the camera is transferring data.</p> <p>You can click this button again to switch LED lights on again.</p>

Click 'Apply' to save settings and make the new settings take effect.

2.6.4 Status

This menu provides all information about this IP camera, like firmware version, system uptime, date / time, and network information.

System

- ✔ Firmware Version : v1.4 (Dec 31 2009 14:46:39)
- ✔ Device Uptime : 12 hours 24 min 27 sec
- ✔ System Time : 2009/01/01 20:24:12

LAN

- ✔ IP Address : 192.168.3.3
- ✔ Subnet Mask : 255.255.255.0
- ✔ Gateway :
- ✔ DNS Server : 168.95.1.1
- ✔ MAC Address : 00:01:55:A3:12:01
- ✔ HTTP Port : 80

PPPoE

- ✔ Link Status : Disconnected
- ✔ IP Address :
- ✔ Subnet Mask :
- ✔ Gateway :
- ✔ DNS Server:

2.7 Account

If you wish to allow other people to view the live image captured by this camera, but don't want to allow them to modify system settings, you can give them user-level user name and password, so they can only view the image and can not change any system setting. When they want to click menus other than 'Camera', they will see the following message informing that they don't have permission to do that:

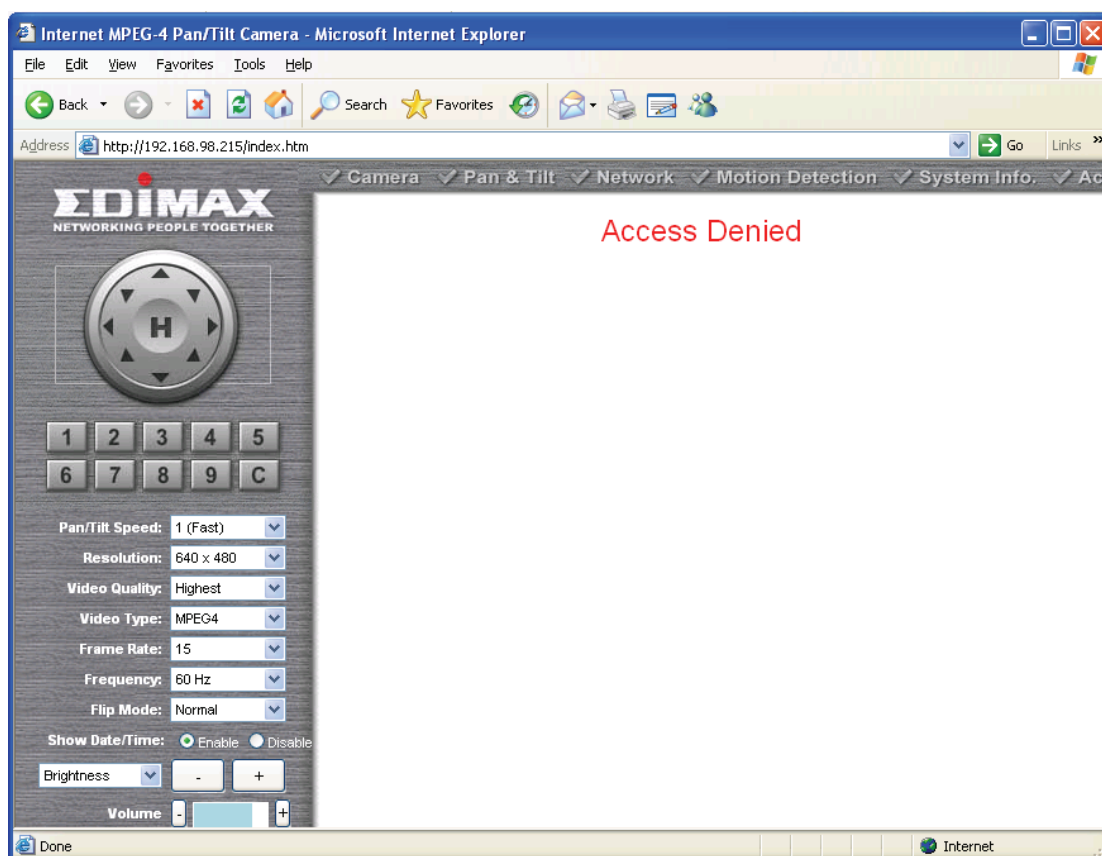

This camera supports up to 4** users.



After you selected 'Account', you'll be prompted to input user account information:

The descriptions of every setting in this menu will be given below:

Item	Description
User List	Lists all users currently available.
Login	Input the login name (user name) of this account.
Password	Input the password of this user here.
Confirm password	Input the password of this user here again for confirmation.
Authority	Select the privilege of this user: Operator (able to change system settings) or Guest (View images only).
Add	Click this button to add the account.
Modify	Modify an existing user's information. You have to select a user from user list first.
Remove	Remove an existing user. You have to select a user from user list first.

Click 'Apply' to save settings and make the new settings take effect.

Please note: only one user (including administrator) will be able to view the image of IP camera at the same time.

2.7 SDHC

...



After you selected 'System Info.', a sub-menu will appear. There are 4 sub-menus available here:

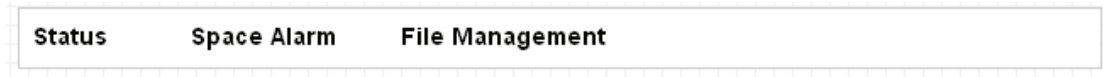

Please click the SD card setting you wish to set, then refer to instructions given below:

2.7.1 Status

Here shows the remaining card space for you.

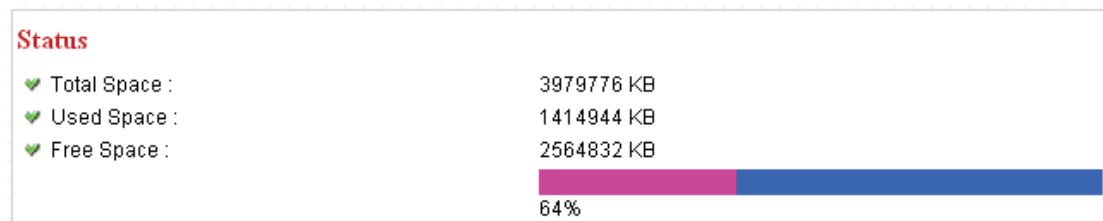

2.7.2 Space Alarm

When you're using SD card to store captured image and video clip, you can have this camera to send an E-mail to you when there's only little remaining space left on SD card.

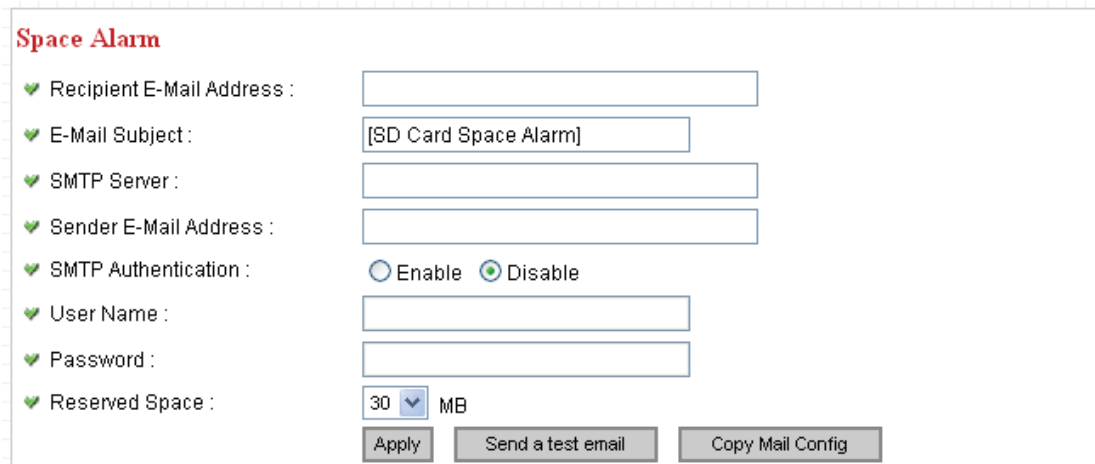

The screenshot shows a configuration window titled "Space Alarm" with the following fields and options:

- Recipient E-Mail Address :
- E-Mail Subject :
- SMTP Server :
- Sender E-Mail Address :
- SMTP Authentication : Enable Disable
- User Name :
- Password :
- Reserved Space :

At the bottom of the form are three buttons: "Apply", "Send a test email", and "Copy Mail Config".

Please note: If you have set E-mail settings in 'Motion Picture' function, you can click 'Copy Mail Config' button to use the same setting. However, you can use a different setting here.

The descriptions of every setting in this menu will be given below:

Item	Description
Recipient E-Mail Address	Input the E-mail address you wish to receive space alarm.
E-Mail Subject	Input the title of space alarm E-mail.
SMTP Server	Input the SMTP server address you wish to use to send E-mail.
Sender E-Mail Address	Input the sender E-mail address of the space alarm E-mail.
SMTP Authentication	Select 'Enable' if the SMTP server you're using requires authentication, and input the username and password below; If the SMTP server you're using does not require authentication, select 'Disable' here. If you're not sure, ask your ISP or network administrator.
Reserved Space	Select the amount of SD card space which will be reserved and will not be used from dropdown menu.

Click 'Apply' to save settings and make the new settings take effect.

You can click 'Send a test email' button to send a test E-Mail by the configuration you set here.

2.7.3 File Management

You can use this menu to manage the files stored on SD card.

File Management



The descriptions of every setting in this menu will be given below:

Item	Description
FirstPage	Jump to first page of file list.
PrevPage	Jump to previous page of file list.
NextPage	Jump to next page of file list.
LastPage	Jump to last page of file list.
SelectAll	Select all files in this page.
ClearAll	Clear all files in this page.
Delete	Delete selected files.

Chapter III: Using Surveillance Software

3-1 Installing IP Camera Surveillance Software

The IP camera surveillance software provides various functions like video recording, after this software is installed, you can use your IP camera to safeguard your property. Please follow the following instructions to install the surveillance software.

1. Double click the setup file located in 'xxx' folder in supplied CD-ROM, when the following window appears, click 'Next'.

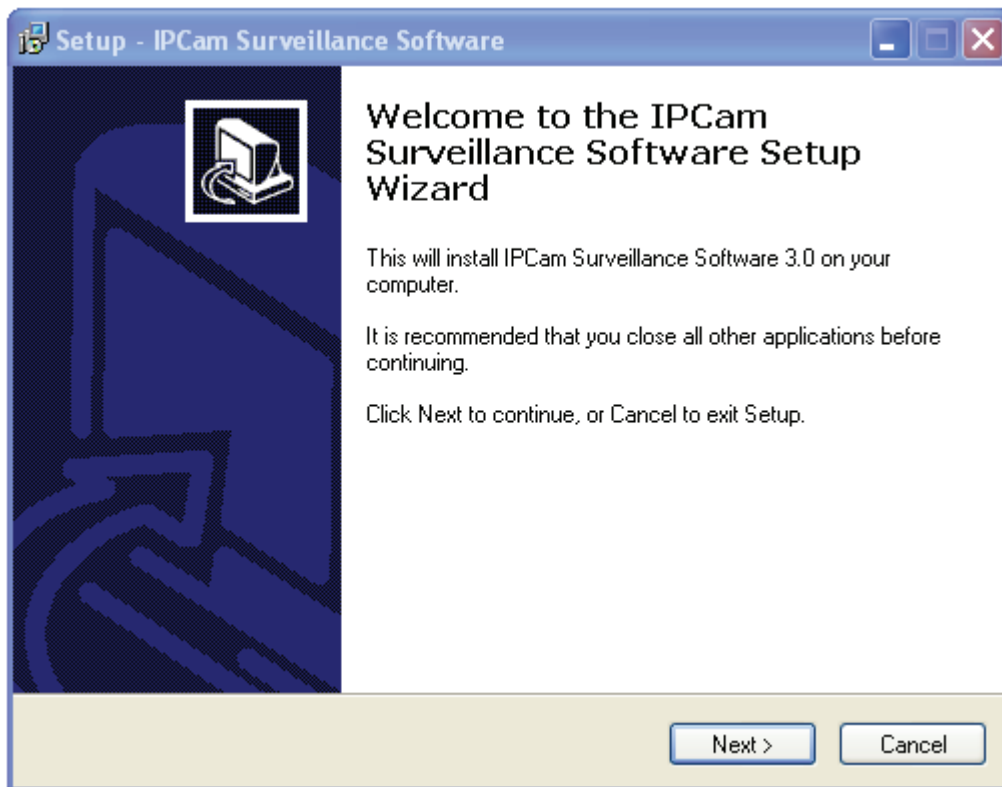

2. You can specify the destination folder of software installation, you can just use the default folder, and click 'Next' to continue.

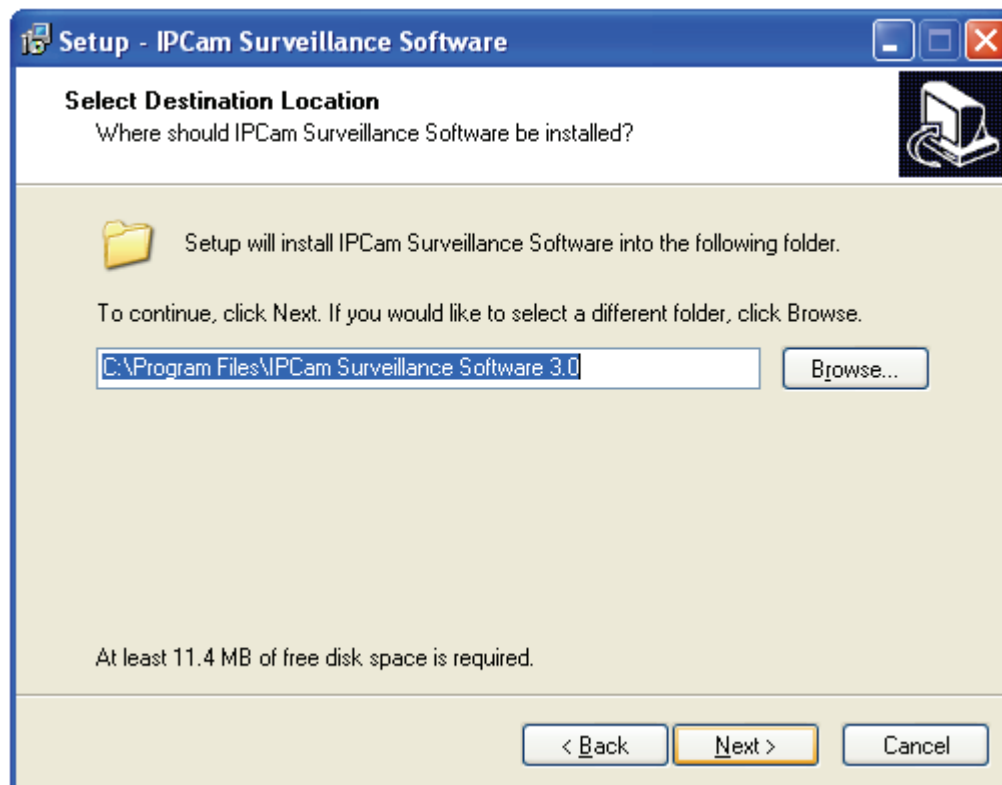

3. If you need installation program to create a desktop icon or a quick launch icon for you, click all items you need here, than click 'Next' to continue.

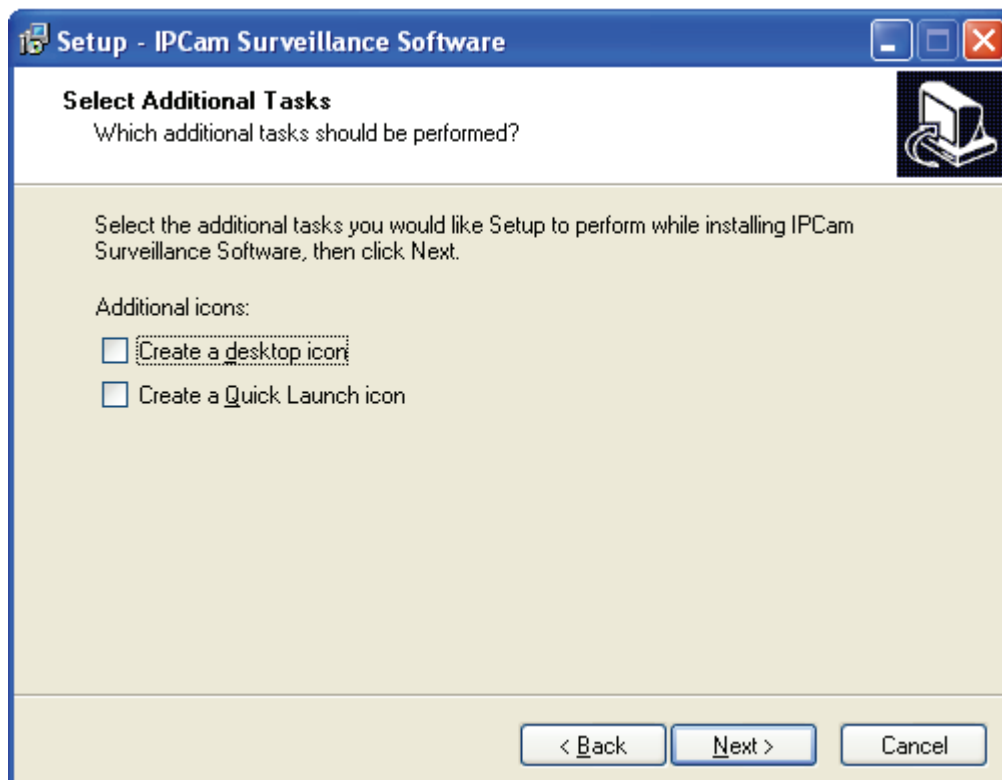

4. Here lists all options you chose in previous steps, if everything's correct, click 'Install' to start installing procedure, or click 'Back' to go back to previous step to modify installing settings.

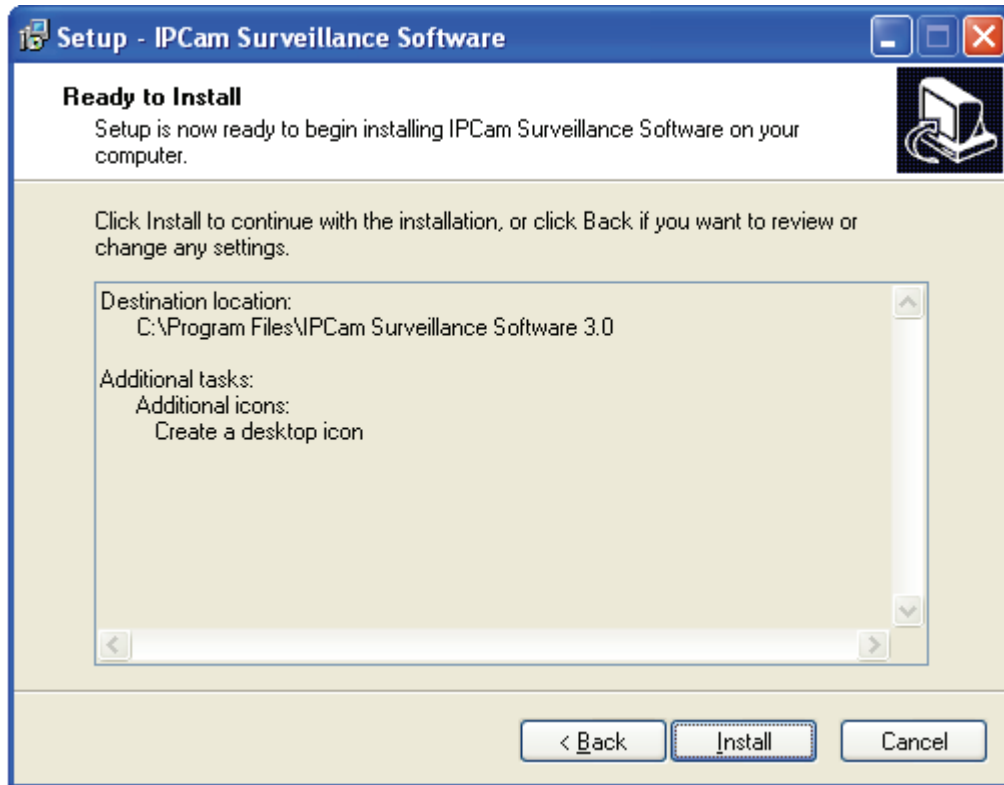

5. The installing procedure will take some time, please be patient.

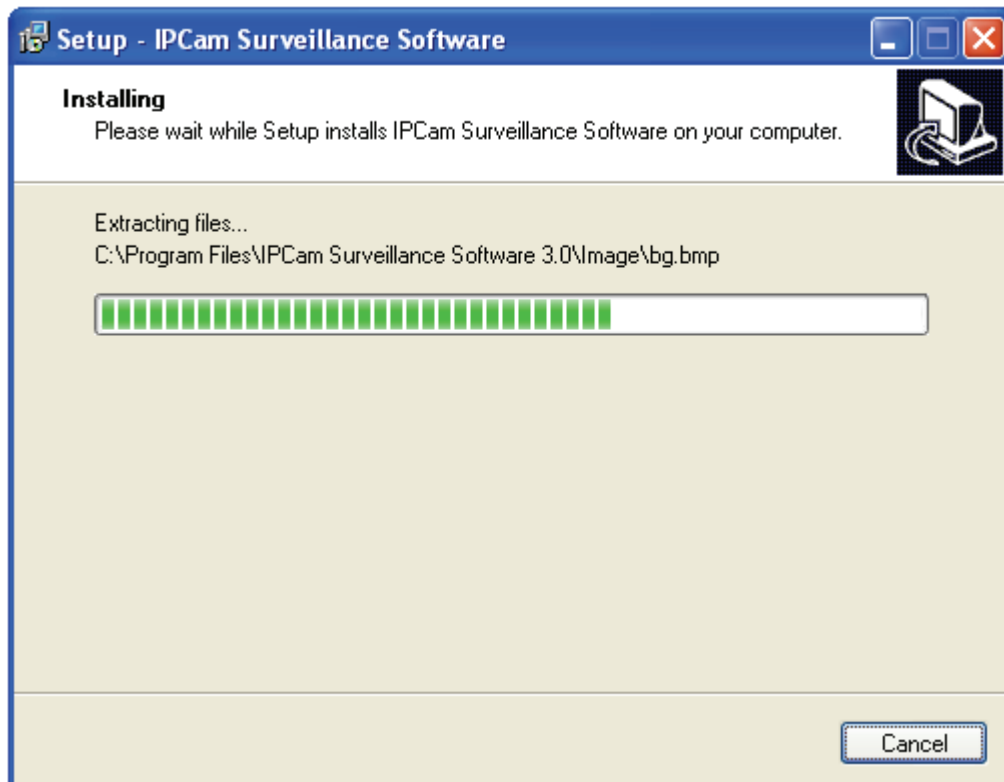

6. When you see this window, it means the software installing procedure is complete. Please click 'Finish' to finish the procedure (IP camera surveillance software will start after you click 'Finish' button, if you want to start it later, uncheck 'Launch IPCam Surveillance Software' box).



3-2 Using IP camera surveillance software

You can click 'IPCam Surveillance Software' icon from desktop, quick launch bar, or start menu to start the IP camera surveillance software.







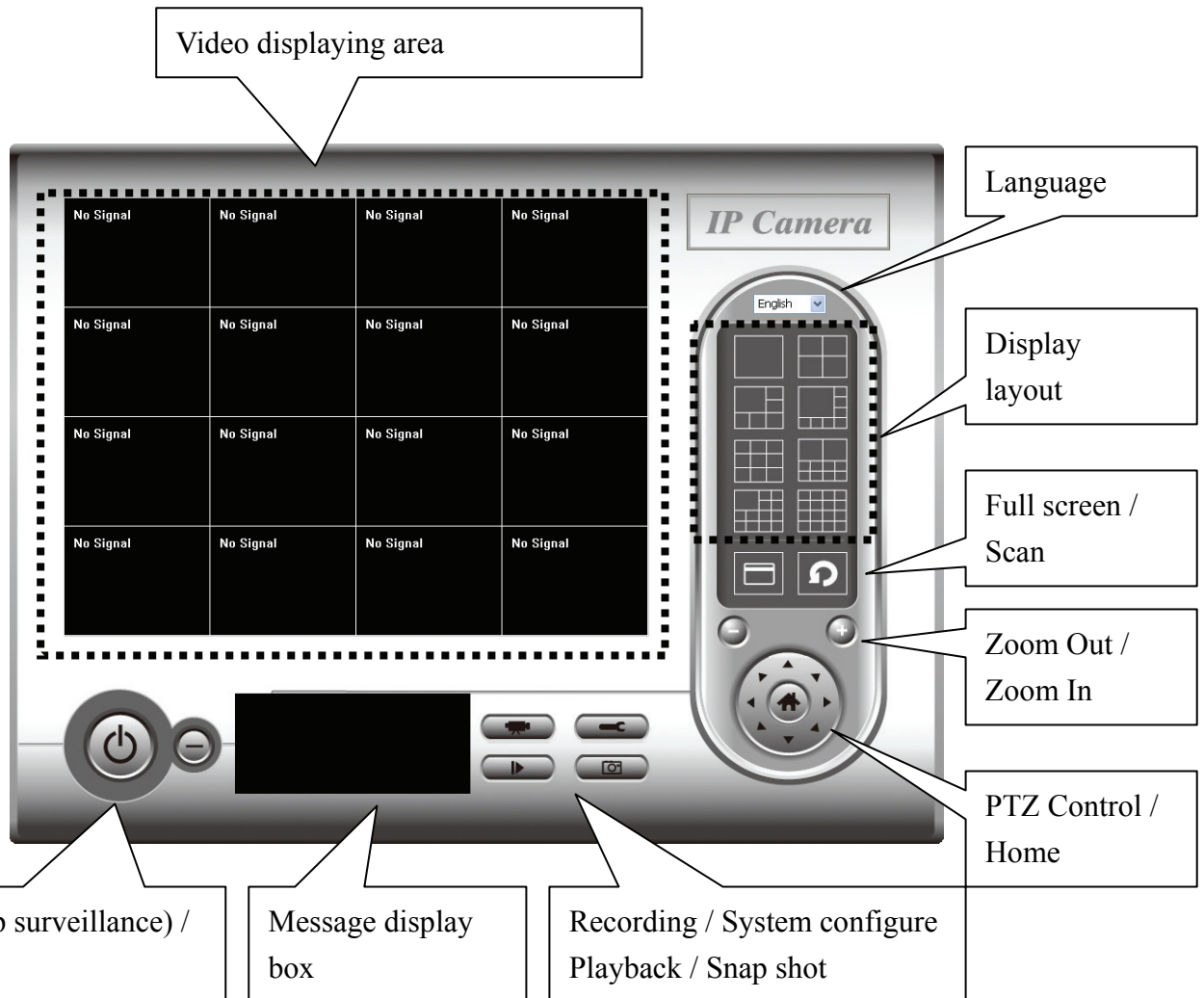



Before you start:



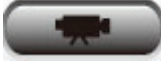

IP camera surveillance software will only work when your monitor's resolution is '1024 x 768'. Please change the resolution before you use IP camera surveillance software, or it won't start.

Here are descriptions for all components of IP camera surveillance software:



You can put the mouse cursor on a certain component and see its button name, and here're detailed descriptions of all buttons:

Item	Description
Video displaying area	The image of all connected cameras will be displayed here.
Language	Select a language from this dropdown menu to change display language.
Display layout 	Change camera image display layout (Click a layout icon to change camera display layout). There are 8 kinds of available display layouts.
Full screen 	Click this button to switch to full screen mode (only display all camera's image), press 'ESC' key to quit full screen mode.
Scan 	Click this button and the IP camera surveillance software will switch displaying the image of all connected camera automatically. Click this button once to activate scan function (scan icon will become blue ) , click again to stop scanning (scan icon will become white ) .
Zoom out 	Zoom-out (To see more objects). This function is only available for supported cameras.
Zoom In 	Zoom-in (Too see more details). This function is only available for supported cameras.
PTZ control 	There are 8 directions in PTZ control ring. If the camera you connect support PTZ, you can use PTZ control ring to change the direction that camera points to. This function is only available for supported cameras.
Home 	Click this button to return the camera to 'Home' (default) position. This function is only available for supported cameras.
Recording 	Start video recording.
Configure 	Software / camera configuration.

<p>Playback</p> 	<p>Playback a recorded video file.</p>
<p>Snapshot</p> 	<p>Take a snapshot of current camera.</p>
<p>Message display</p>	<p>Displays all system messages like camera is disconnected etc.</p>
<p>Close window (stop surveillance)</p> 	<p>Terminates IP camera surveillance software.</p>
<p>Minimize window</p> 	<p>Minimizes IP camera surveillance software window.</p>
<p>Video displaying area</p>	<p>Displays the image of all cameras by the display layout you selected.</p>

3-3 Configure IP camera surveillance software

3-3-1 Configure cameras

Before you use this IP camera surveillance software, you must configure the camera(s) you wish to connect. Please click 'System configure' button  and a popup menu will appear:

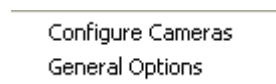

Please select 'Configure Cameras' to configure cameras:

Note: If you're prompted by a windows security alert which asks you if you want to block 'IPCamViewer' program, please click 'Unblock' button, of IP camera surveillance software will not be able to function correctly.



3-3-1-1 'Camera' tab

In this tab you can configure all cameras you wish to connect. Up to 16 cameras can be connected simultaneously:

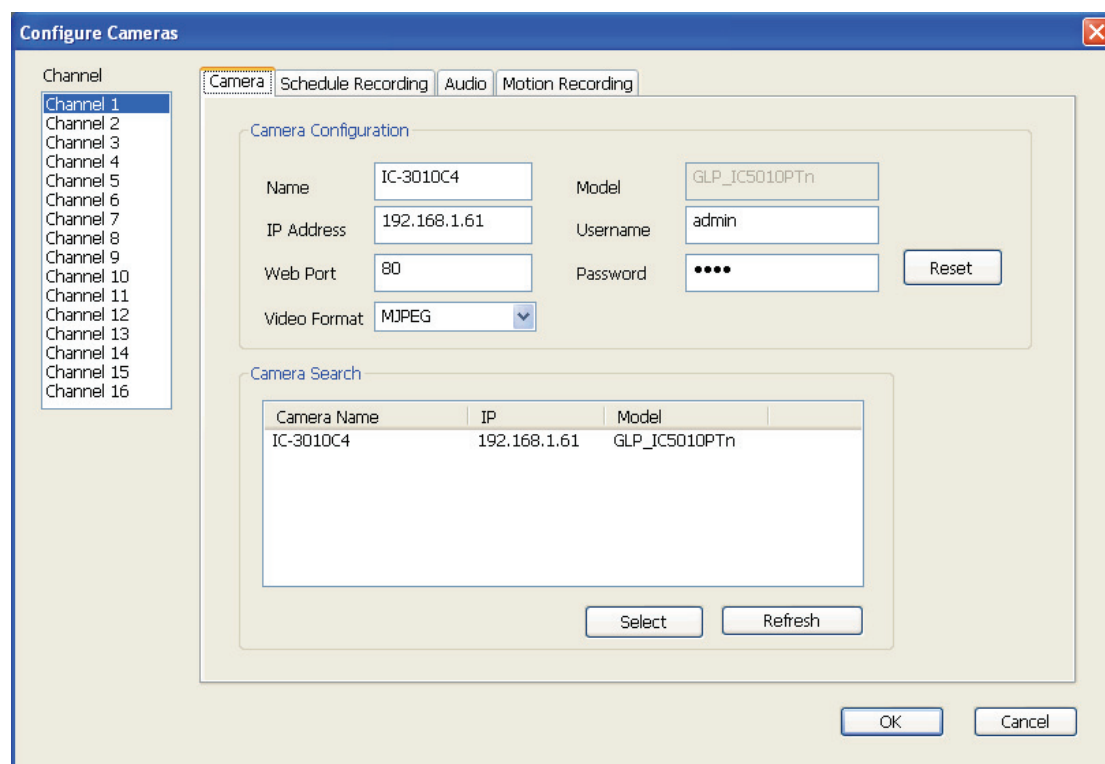

Here are the descriptions of all setting items:

Item	Description
Channel	Select the channel number you wish to set.
Camera Search	All cameras found on your local network will be displayed in 'Camera Search' box.
Select	Select a camera listed in 'Camera Search' box, and click 'Select' button to fill all parameters of selected camera in every camera configuration fields.
Refresh	Rescan all cameras on your local network. If you didn't see the camera you expected in 'Camera Search' box, or new cameras has been joined to your local network after last scan.

Name*	Input the name of camera here. Default value is the first 6 bytes of camera's MAC address, you can change the name of camera so you can remember the camera's location of purpose easily.
Model	Displays the model of selected camera, this field can not be changed.
IP*	Input the IP address of camera.
Username*	Input the user name of camera.
Web Port*	Input the web port of the camera. By default it's '80'.
Password	Input the password of camera. Default value is '1234'. You should change the password if you changed the password of selected camera.
Video Format**	Select the video encoding format of this camera (MJPEG or MPEG4).
Reset	Clear all fields in 'Camera Configuration' section.
OK	Save settings in this tab.
Cancel	Discard all settings in this tab.

*: It's recommended to use 'Select' button to fill the content of this field.

** : Only available for cameras support this function.

After you've set all channels you wish to set, click 'OK' to save settings, and if everything's correct, you'll see the camera's image in IP camera surveillance software's main menu:



3-3-1-2 Schedule Recording

In this tab, you can setup scheduled video recording, so you can record the video captured by all cameras you have by a pre-defined schedule.

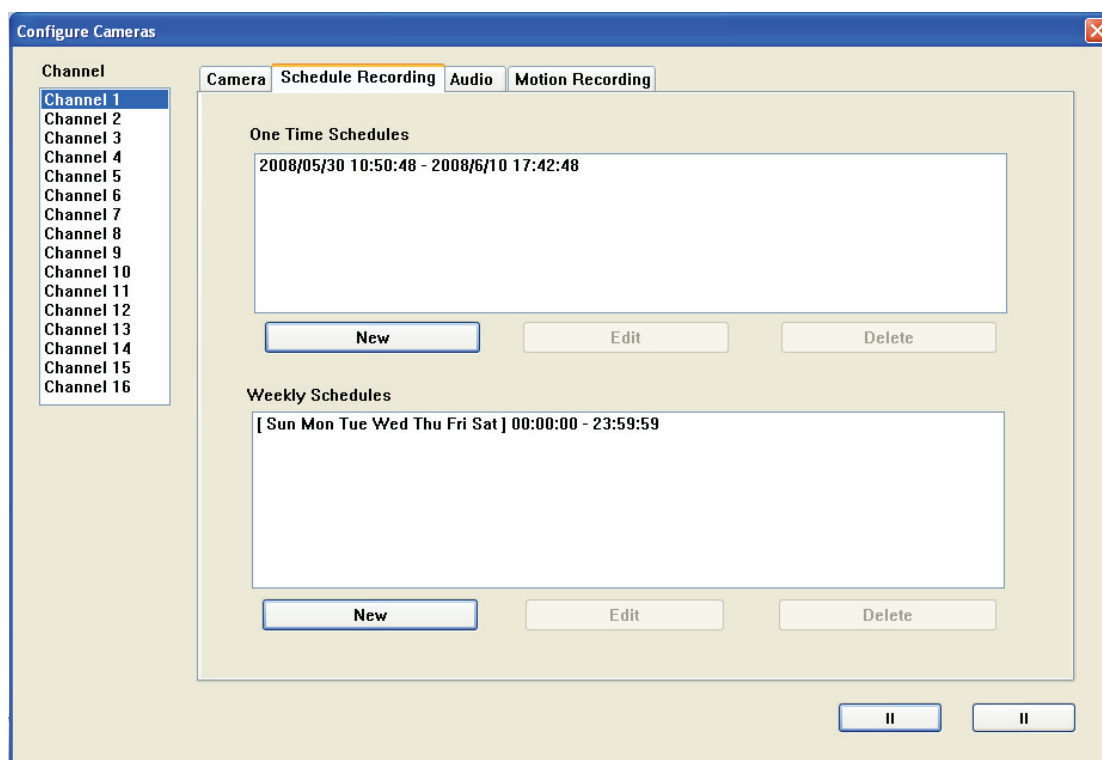

Here are the descriptions of all setting items:

Item	Description
Channel	Select the channel number you wish to set.
One Time Schedules	You can specify the one-time schedule for selected camera; this schedule will be executed once only.

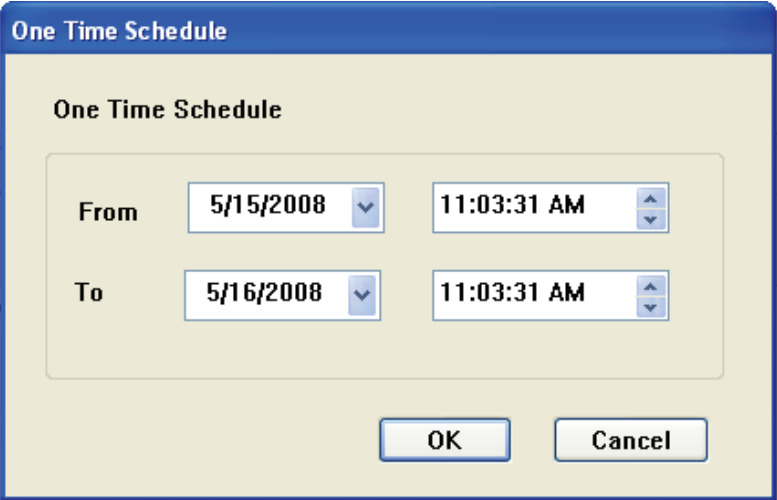
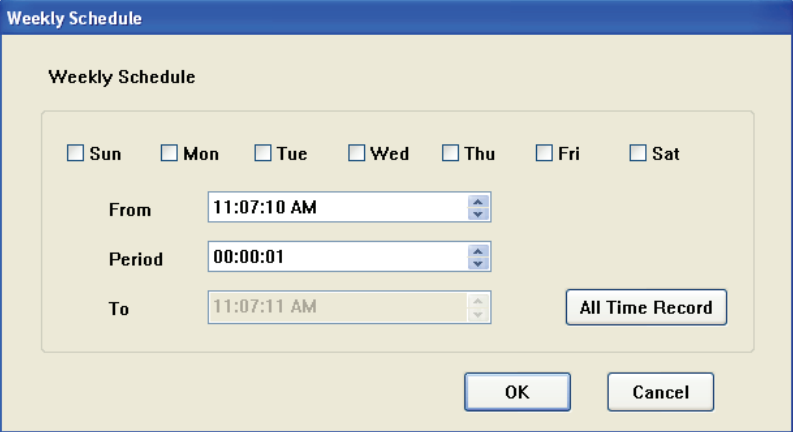
<p>New (One Time Schedules)</p>	<p>Click this button and a new window will appear:</p>  <p>Please specify the time duration of this one-time schedule (the date and time of 'From' and 'To'), then click 'OK' to save settings.</p> <p>Please note you must set a schedule that will be happened in the future, you can not set a schedule in the past.</p>
<p>Edit</p>	<p>You can modify a scheduled recording item. Select a schedule in 'One Time Schedules' list, and click 'Edit' button to edit the start and end time of this schedule.</p>
<p>Delete</p>	<p>Delete a selected schedule item.</p>
<p>New (Weekly Schedules)</p>	<p>Click this button and a new window will appear:</p> 

	<p>You can define recording schedule that will be executed at the specified time of certain weekday(s) in a week. Please check all weekdays that applies, and set the start time in 'From' field. You can set the duration of video recording in 'Period' field (format is HH:MM:SS), and the end time will be calculated automatically and displayed in 'To' field. You can also click 'All Time Record' button to define a recording schedule that will be executed every weekday, from 12:00:00AM to 11:59:59PM.</p> <p>Click 'OK' to save changes.</p>
Edit	You can modify a scheduled recording item. Select a schedule in 'One Time Schedules' list, and click 'Edit' button to edit the start and end time of this schedule.
Delete	Delete a selected schedule item.
OK	Save settings in this tab.
Cancel	Discard all settings in this tab.

3-3-1-3 Audio

For cameras that support audio, you can use this tab to decide if you wish to hear the audio captured by selected camera.

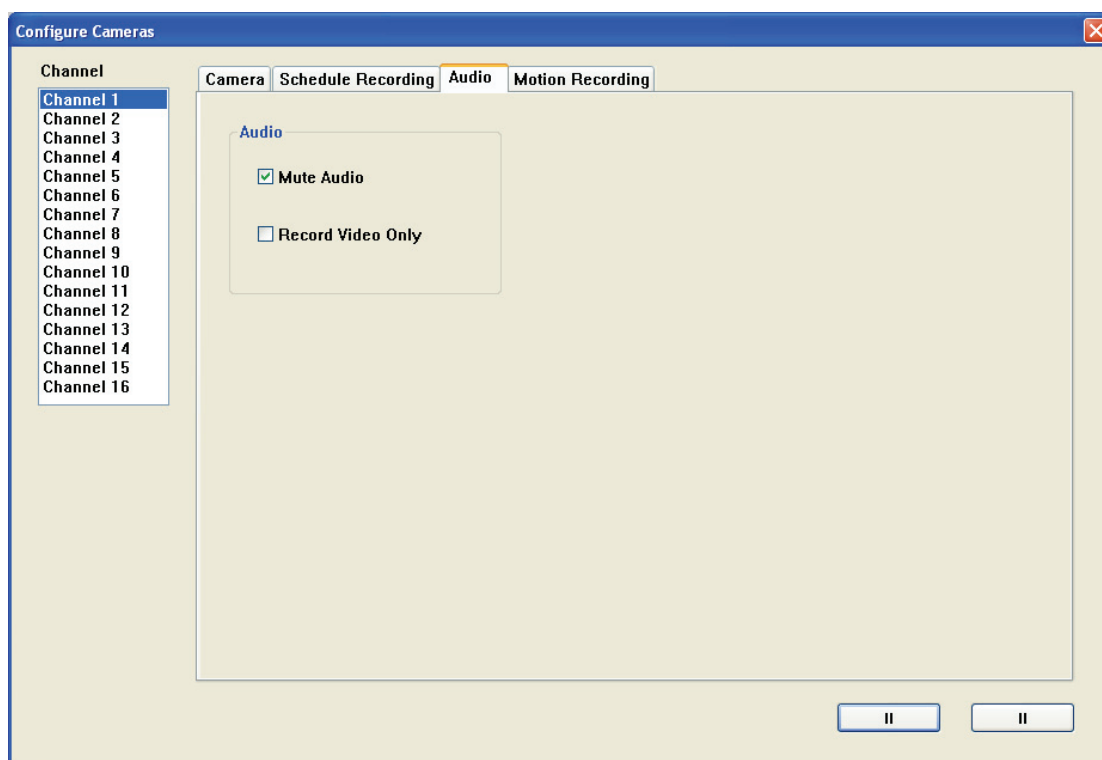

Here are the descriptions of all setting items:

Item	Description
Channel	Select the channel number you wish to set.
Mute Audio	Check this box and the IP camera surveillance software will not play the audio captured by this camera.
Record Video Only	Check this box and the IP camera surveillance software will not record the audio captured by this camera.
OK	Save settings in this tab.
Cancel	Discard all settings in this tab.

3-3-1-4 Motion Record

With this function activated, only motions captured by the camera will be recorded, so you don't have to waste hard disk storage space on images you don't need to pay attention to.

WARNING: For applications that security is highly concerned, it's not recommended to use this function since some tiny changes you may need to know may not be able to trigger the camera and the camera will not start recording.

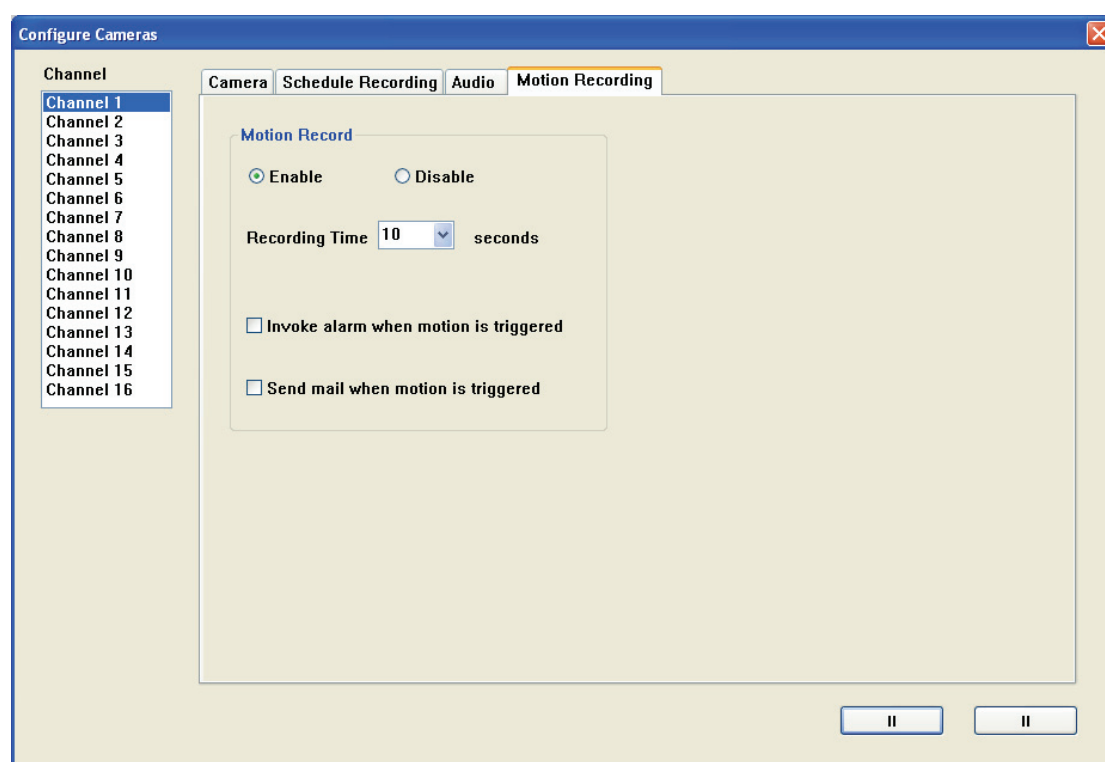

Here are the descriptions of all setting items:

Item	Description
Channel	Select the channel number you wish to set.
Enable	Enable motion record function.
Disable	Disable motion record function.
Recording Time	Select the time duration that camera will record when a motion has been detected from dropdown menu in seconds.

Invoke alarm when motion is triggered	Send an alarm when a motion has been detected by the camera.
Send mail when motion is triggered	Send an email to a pre-defined address when a motion has been detected by the camera.
OK	Save settings in this tab.
Cancel	Discard all settings in this tab.

3-3-2 General Settings

You can set system-wide settings of this IP camera surveillance software in this menu.

3-3-2-1 'General' tab

All general settings like file storage directory and recording spaces can be set here.

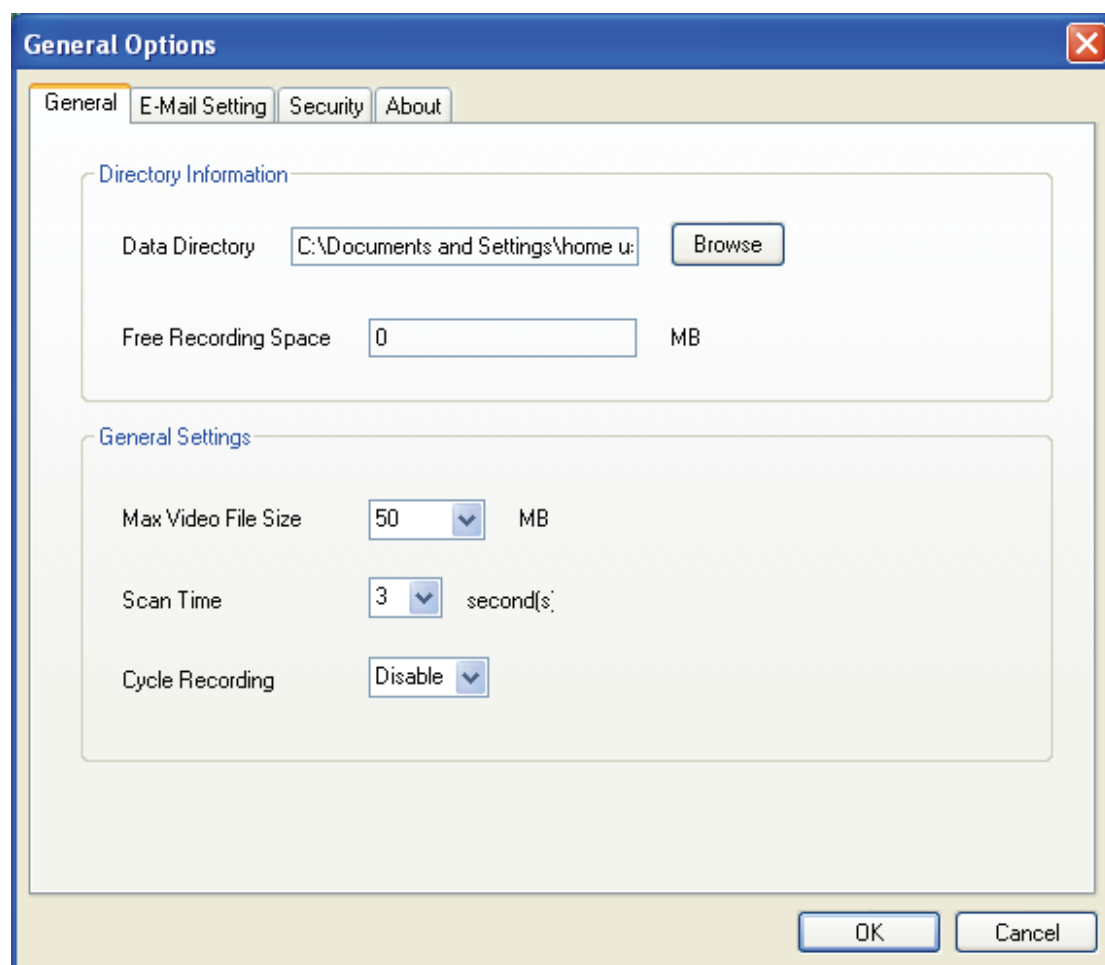

Here are the descriptions of all setting items:

Item	Description
Data Directory	Set the directory (folder) you wish to store the recorded video and captured image. You can click 'Browse' button to pick a directory in your hard disk.

Free Recording Space	Displays remaining storage space.
Max Video File Size	Defines the maximum file size of every video file. When the size of file exceeds this value, IP camera surveillance software will open another file to record the video.
Scan Time	Define the time period to pause between every camera switch when you activate 'Scan' function.
Cycle Recording	You can decide the behavior when hard disk space is full: Disable: Do not overwrite recorded video files. Enable: Overwrite recorded video files.
OK	Save settings in this tab.
Cancel	Discard all settings in this tab.

3-3-2-2 'E-Mail Setting' tab

If you want to use motion detection function and wish to get an email that contains the image captured by the camera, please setup your email related parameters here first.

The screenshot shows a window titled "General Options" with a close button in the top right corner. It has four tabs: "General", "E-Mail Setting", "Security", and "About". The "E-Mail Setting" tab is selected. The window contains the following fields and controls:

- E-Mail Subject: A text input field.
- Recipient E-Mail Address: A large text input field.
- Buttons: "New", "Edit", and "Delete" buttons are positioned below the Recipient E-Mail Address field.
- Sender E-Mail Address: A text input field.
- SMTP Server: A text input field.
- SMTP Port: A text input field containing the value "25".
- SMTP Auth: Two radio buttons, "Enable" and "Disable". The "Disable" radio button is selected.
- SMTP Account: A text input field.
- SMTP Password: A text input field.
- Buttons: "OK" and "Cancel" buttons are located at the bottom right of the dialog.

Here are the descriptions of all setting items:

Item	Description
E-Mail Subject	Specify the subject of sending email.
Recipient E-Mail Address	Here lists all email addresses you set.
New	Click this button and you'll be prompted to input the email address. Click 'OK' to save changes.

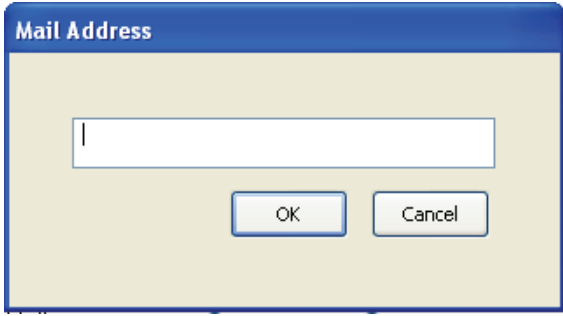
	
Edit	Select an email address from 'Recipient E-Mail Address' box, and click 'Edit' to edit the email address.
Delete	Delete selected email address.
Sender E-Mail Address	Specify the email address of email sender.
SMTP Server	Specify the IP address or host name of the SMTP server you wish to use. For most of ISPs they will only allow its subscriber to use their SMTP server, if you don't know which SMTP server you should use, please refer to the setting of your email software or ask your ISP / network administrator.
SMTP port	Specify the port number of the SMTP server you wish to use here. By default (and the setting of most of SMTP servers) it's '25'.
SMTP Auth	Select 'Enable' if your SMTP server requires authentication, select 'Disable' if it's not required. If you don't know if your SMTP server requires authentication, please refer to the setting of your email software or ask your ISP / network administrator.
SMTP Account	Input the SMTP account (username) of your SMTP server here. In most cases, it's the same with your POP3 username (the one you used to receive email). Please refer to the setting of your email software or ask your ISP / network administrator if you're not sure about this.
SMTP Password	Input the SMTP password of your SMTP server here. In most cases, it's the same with your POP3 password (the one you used to receive email). Please refer to the setting of your email software or ask your ISP / network administrator if you're not sure about this.
OK	Save settings in this tab.
Cancel	Discard all settings in this tab.

3-3-2-3 Security

If you don't want other people to access this IP camera surveillance software, you can set a password to protect it.

You'll need to input the password every time you wish to use this IP camera surveillance software:

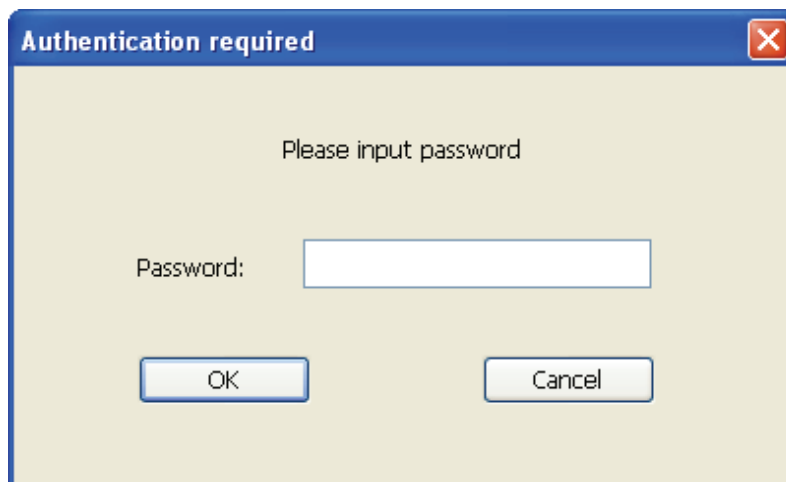

To set password, please use 'Security' tab in 'General Options' menu:

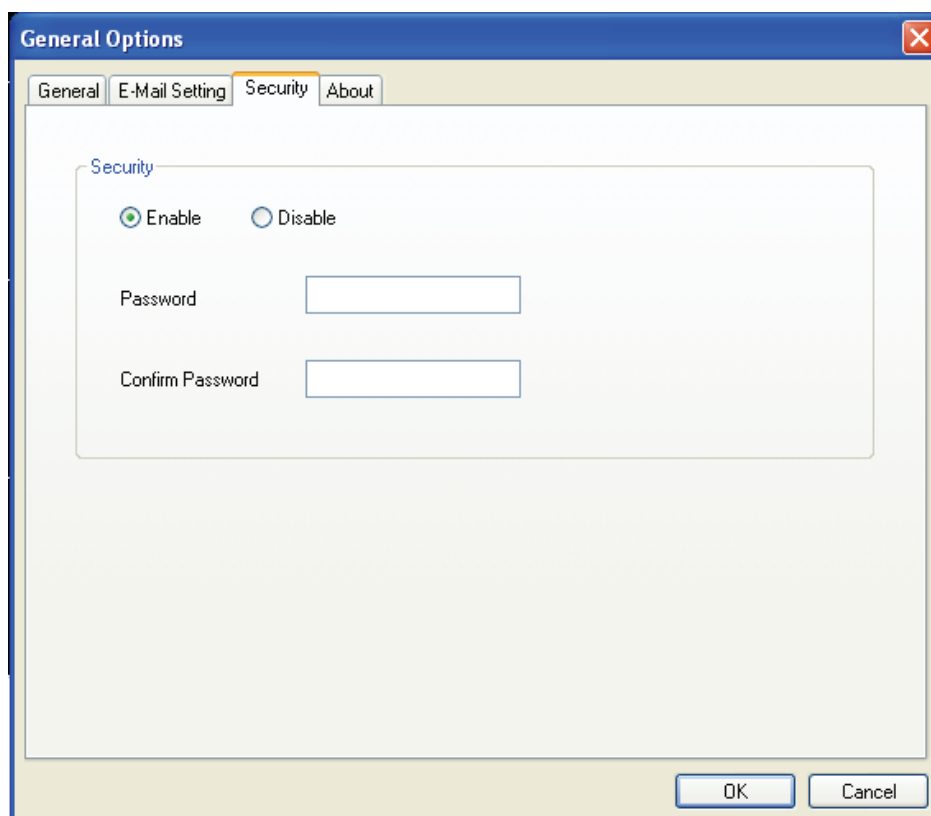

Here are the descriptions of all setting items:

Item	Description
Enable	Requires password authentication when this software starts.
Disable	Password authentication is not required when this software starts.
Password	Input the password you wish to use here.
Confirm Password	Input the password you wish to use here again.

3-3-2-4 About

This tab shows the version number of the IP camera surveillance software you're using.

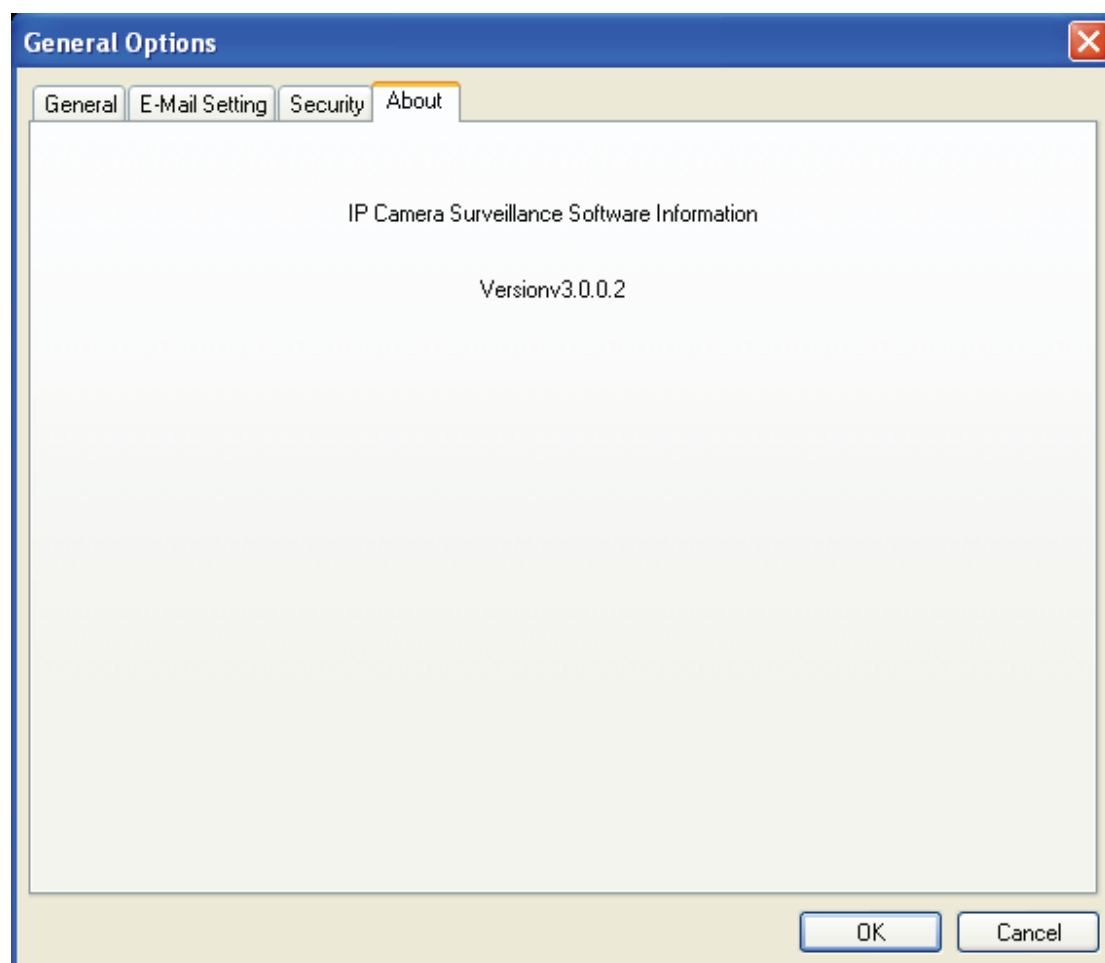





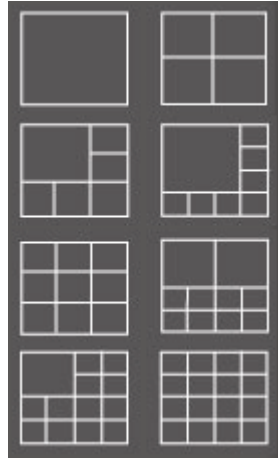

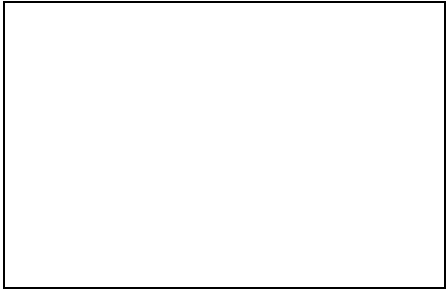

3-4 Change Display Layout

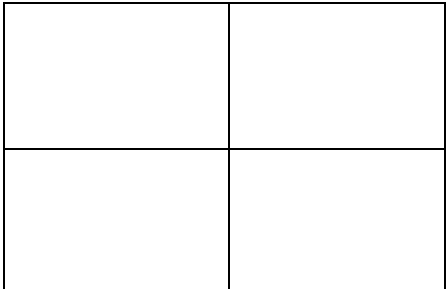
This IP camera surveillance software provides 8 kinds of display layout:

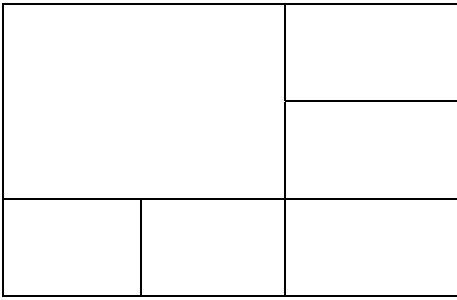

Every layout displays different number of camera and camera arrangement, you can click the icon that presents a specific kind of layout, and the video displaying area will change accordingly.

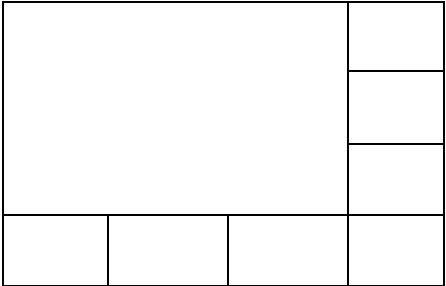
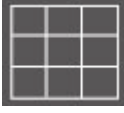
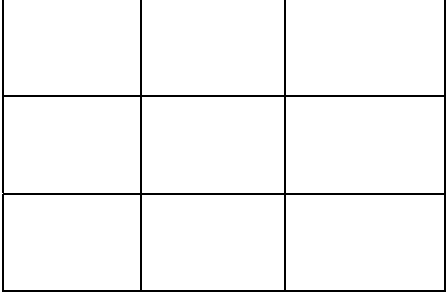
<p>Layout style 1: 1 Camera only</p> 	<p>Displays the video of 1 camera only.</p> 
<p>Layout style 2: 4 Cameras</p> 	<p>Displays the video of up to 4 cameras.</p> 

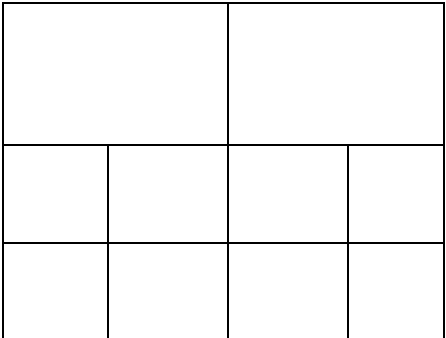
<p>Layout style 3: 6 Cameras</p> 	<p>Displays the video of up to 6 cameras.</p> 
<p>Layout style 4: 8 Cameras</p> 	<p>Displays the video of up to 8 cameras.</p> 
<p>Layout style 5: 9 Cameras</p> 	<p>Displays the video of up to 9 cameras.</p> 
<p>Layout style 6: 10 Cameras</p> 	<p>Displays the video of up to 10 cameras.</p> 

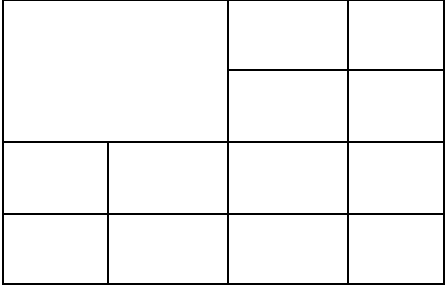
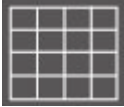
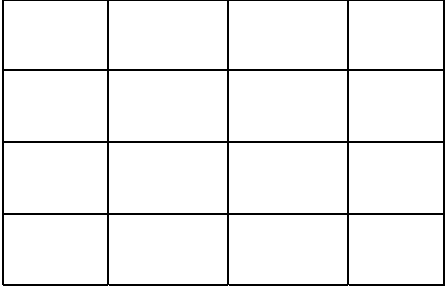
<p>Layout style 7: 13 Cameras</p> 	<p>Displays the video of up to 13 cameras.</p> 
<p>Layout style 8: 16 Cameras</p> 	<p>Displays the video of up to 16 cameras.</p> 

3-5 Full-screen mode

If you want to use all available spaces on your monitor to display surveillance image, you can click 'Full Screen' button to switch display mode to full-screen mode.

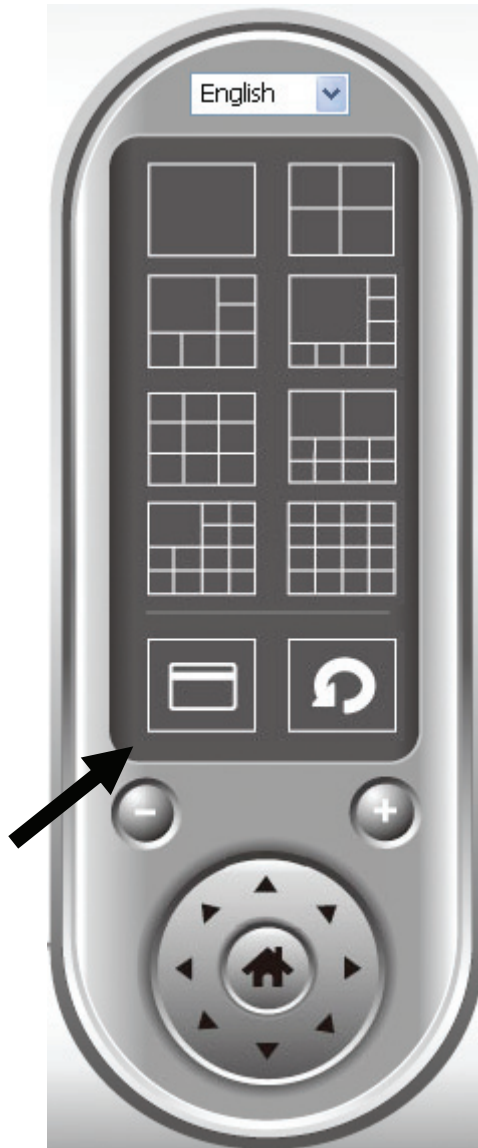



To exit full-screen mode, press 'ESC' key.

3-6 Scan

If you have more than one camera configured, and you wish to switch the displaying image between cameras, you can click 'Scan' button to switch between all configured cameras.

NOTE: If a camera is configured but disconnected, it will still be displayed in a scan sequence (you'll see nothing and you'll see 'Disconnected' text displayed at the upper-left corner of display image).





Click 'Scan' button once to activate scan function (scan icon will become blue ) , click again to stop scanning (scan icon will become white ).

3-7 Zoom-in / Zoom-out

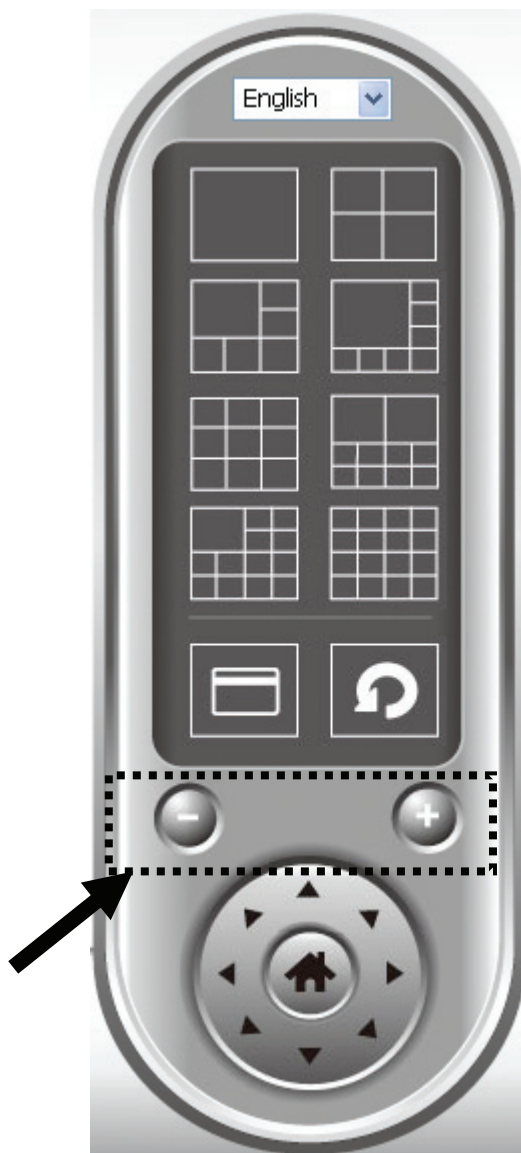
For cameras that support zoom-in / zoom-out function, you can use this function to see more objects that fall in the scope of camera's view, or enlarge the image size of a certain object to see its detail.



Please select a camera in video displaying area by clicking on its image, then click  button to see more objects that fall in the scope of camera's view, or click  to enlarge the image size of a certain object to see its detail (Before zoom-in, you may need to use PTZ buttons - described in next section) to find an object you wish to see its detail).

3-8 PTZ

For cameras that support pan - tilt function, you can change the position that camera points to, to see different places that fall in the scope of camera's view.



Please select a camera in video displaying area by clicking on its image, and then click the directions you wish the camera to move to (total 8 directions available). Click 'Home' button (🏠) to return to camera's home (default) position.

3-9 Snapshot

You can take a snapshot of selected camera and save it to 'Snapshot' sub-folder of pre-defined data directory.

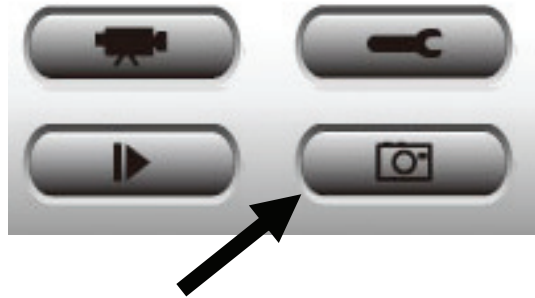

Click snapshot button once to take a snapshot; you can take as much snapshot as you want before hard disk is full.

3-10 Recording

You can start video recording of selected camera manually by clicking 'Start Recording' button:



When recording starts, you'll see a message displayed in message displaying box like '1/1 10:00:00, Camera 2 Start Manual', which means camera 1 starts recording manually on 1/1 at 10:00:00.

To stop recording, click 'Start Recording' button again, and you'll see a message displayed in message displaying box like '1/1 10:00:00, Camera 2 Stop Manual'.

3-11 Video Playback

You can playback all recorded video by clicking this button.



A new window will appear:

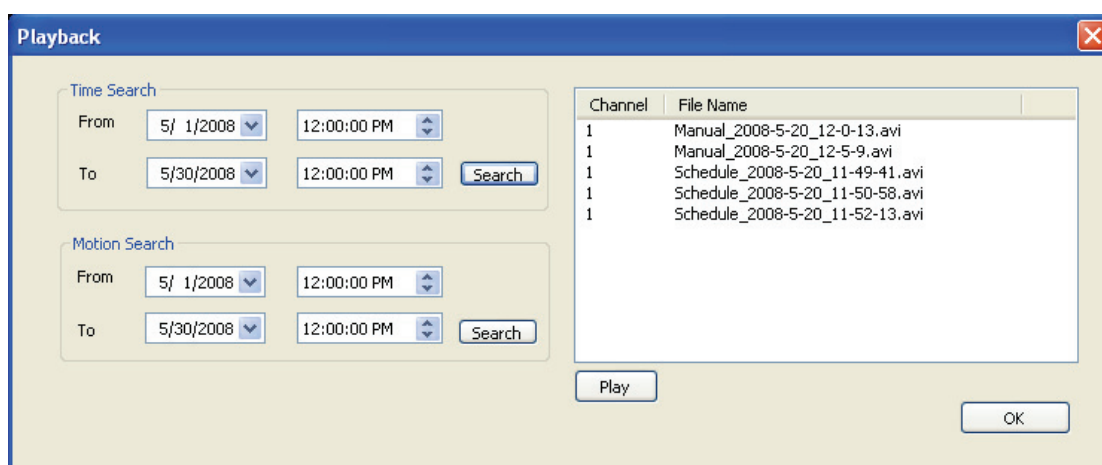

You have to search the video file before you can play it. There are two kinds of video search: Time Search (search all videos file that falls in a specific period of time) and Motion Search (search all videos recorded by motion detection function and falls in a specific period of time).

Please define the start and end date / time of the time period you wish to search, and then click 'Search' button (of 'Time Search' of 'Motion' Search'). All found videos will be displayed, select the video you wish to play and click 'Play' button to playback.

Chapter IV: Appendix

4.1 Specification

Max Resolution: 1280 x 1024 pixels

Sensor: 1.3Mega Pixel 1/4" color CMOS sensor

Gain control: Automatic

Exposure: Automatic

White Balance: Automatic

FNO.=2.0

Image (Video Setting)

Image compression: MJPEG/MPEG4/H.264 Image Video

Frame rate: 30fps@VGA,QVGA, 10-15fps@SXGA,XGA

Video resolution: MJPG/H.264 1280x1024/640x480/320x240

MPEG4 1024x768/640x480/320x240

System Hardware

LAN Connector: One RJ-45 port to connect to 10/100Mbps Ethernet

Wireless: IEEE 802.11b/g/n (*Wireless Model Only)

LED Indicator: Power/Audio/Activity or WLAN/LAN

HTTP/Utility

Includes easy-to-use Viewer & Recorder utility

Provides Admin utility & WEB browser Management

View multiple cameras simultaneously - Up to 16 cameras at a time

Supports four additional user accounts for viewing camera

Auto sending Snap Shot by E-mail or FTP

Support DDNS and UPnP functions

Supports Windows 2000/XP/Vista/7

Firmware Upgradeable

EMI & Safety

FCC, CE Class B

4.2 Troubleshooting

If the IP camera is not working properly, before you contact the dealer of purchase for help, please check the troubleshooting list here, this may help you to solve the problem by yourself and therefore saves your valuable time.

Scenario	Possible Solution
I can not connect to IP camera	<p>a. Please confirm the IP address setting of the computer you're using. If they're not in the same subnet, they will not be able to communicate with each other.</p> <p>b. Please make the IP address you used to connect to the IP camera is correct.</p> <p>c. If you forget the IP address of the IP camera, you will have to reset it to factory default value (which is 192.168.2.3) by pressing 'reset' button at the bottom of the IP camera. You'll need a pen or pin to be able to press the reset button. Press and hold reset button for 5 seconds, then try to connect to the IP camera with IP address '192.168.2.3' again.</p> <p>d. Please make sure IP camera is correctly powered (the 'Power' LED should be on).</p> <p>e. If you're trying to connect to the IP camera from Internet, please make sure the port that IP camera uses (Video and HTTP port, see section 2.3.1) is not blocked by firewall or other software / hardware.</p> <p>f. Contact dealer of purchase for help, if above solutions do not work.</p>
Image refreshes very slow	<p>a. Try a higher frame rate setting, if it's not 30.</p> <p>b. Try a lower resolution.</p>

	<p>c. If you're connecting this camera from Internet, it could be caused by a slow Internet connection, and it's not a problem caused by camera. However, when the network connection is slow, you should use lower frame rate / resolution.</p> <p>d. Adjust the antenna if you're using wireless connection. The antenna should be perpendicular to the ground to get best reception, and the distance between IP camera and computer / wireless access point should not be too far.</p> <p>e. Try to adjust 'MTU' setting if you're using PPPoE to connect to Internet. Ask your ISP or network administrator for detailed instruction.</p>
IP camera is not responding	<p>a. Is the network cable or wireless connection disconnected? Please check it.</p> <p>b. Unplug the power adapter from wall socket and plug it in again after 10 seconds, then try to connect to the IP camera again.</p> <p>c. If IP camera is correctly powered ('Power' LED is on), but you still can not connect to the camera when you're sure that IP address is correct, please contact dealer of purchase for help).</p>
Image is fuzzy	<p>a. Adjust the focus ring on the camera until the image becomes clear.</p> <p>b. Use a soft cloth to clean the lens on the camera. You can use cloth with water, but <i>DO NOT</i> use alcohol or other chemical solution.</p> <p>c. Try to adjust brightness setting.</p> <p>d. If there's any light at the place where IP camera is located, switch it on and see if image looks better.</p>

<p>I set the IP camera to send image by Email or FTP, but nothing is received</p>	<p>a. If the image is send by Email, please make sure it's not blocked by any anti-spam mechanism.</p> <p>b. Please make sure you have enough permission for FTP uploading (You can try this by clicking 'Upload a test file' button).</p> <p>c. Make sure the user name and / or password of SMTP server is correct, if your SMTP server requires authentication (You can try this by click 'Send a test Email' button).</p> <p>d. Please check log, if FTP upload or Email sending is failed, it will be logged, and this may give you some clue on how to solve the problem.</p> <p>e. Change the threshold to a more sensitive setting.</p>
<p>I heard strange sound when I use pan / tilt function</p>	<p>a. Please check if anything jams the camera, remove it.</p> <p>a. If the camera does not respond to you when you're trying to use pan / tilt function, the servo motor inside the camera may dead. Please return the camera to the dealer of purchase and ask for help.</p>
<p>Nothing is heard at the camera side when I use 'Speak to IPCam' function</p>	<p>An external speaker is required to playback the voice received at computer side.</p>

4.3 Obtain a free DynDNS account

If your ISP is issuing dynamic (non-static) IP address to you and you can't connect to your IP camera when you're away from it, you can follow the following steps to obtain a free DynDNS account, which will provide you free IP address to host name mapping service:

1. Launch your web browser and navigate to <http://www.dyndns.org>



2. Click 'Sign In' button (located at upper-right corner of dyndns.org's webpage)

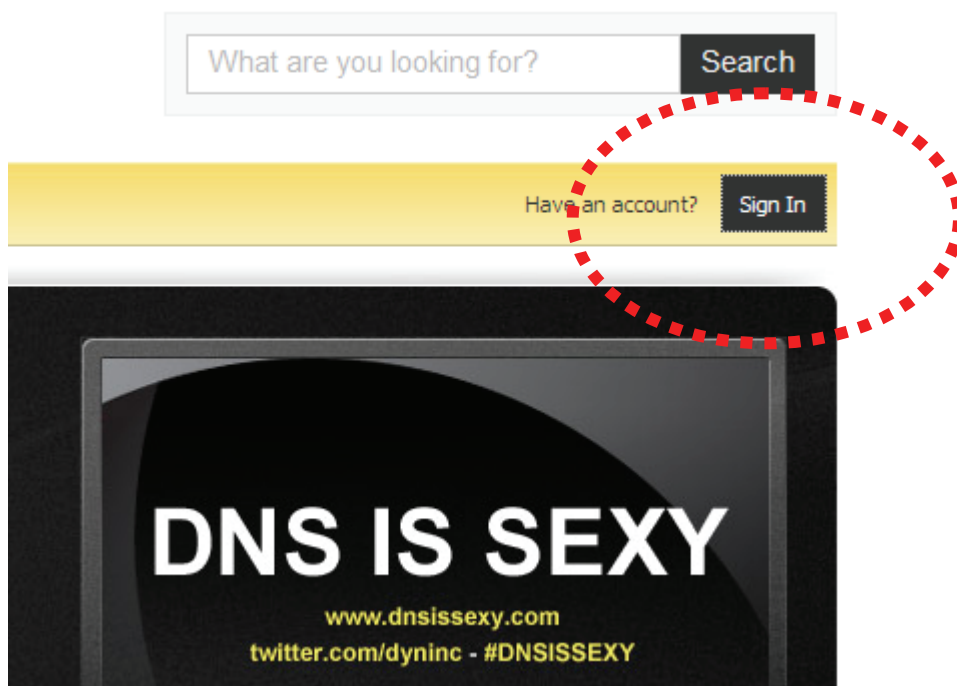

3. Click 'Create an Account' in pop-up menu.

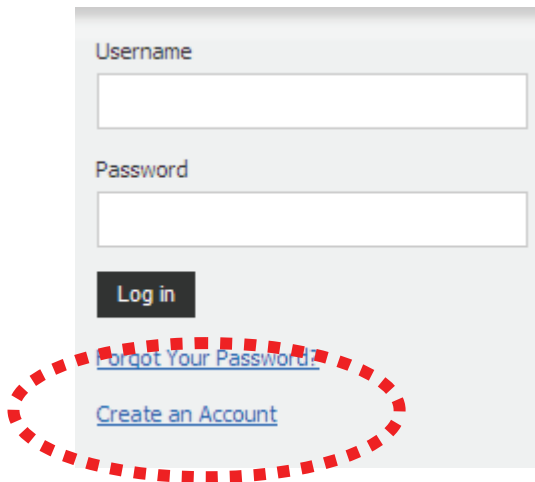

A screenshot of a login form. It contains two input fields: 'Username' and 'Password'. Below the 'Password' field is a 'Log in' button. At the bottom of the form, there are two links: 'Forgot Your Password?' and 'Create an Account'. The 'Create an Account' link is circled with a red dashed line.

4. Fill all fields appear in this menu, and click 'Create Account' button to create a new account. You'll be prompted if the account you selected is not available.

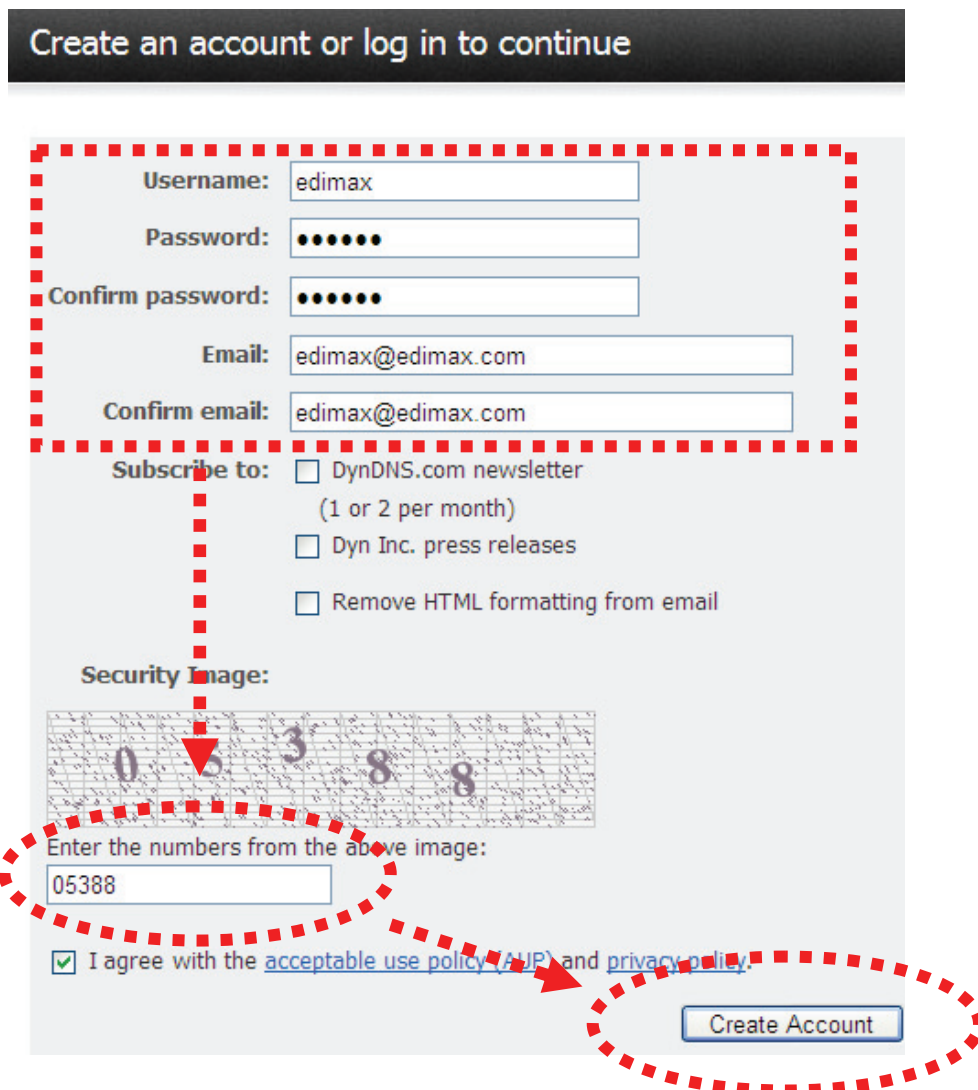

A screenshot of a registration form titled 'Create an account or log in to continue'. The form is filled with the following information:

- Username: edimax
- Password: ••••••
- Confirm password: ••••••
- Email: edimax@edimax.com
- Confirm email: edimax@edimax.com

Below the email fields, there are three checkboxes under 'Subscribe to':

- DynDNS.com newsletter (1 or 2 per month)
- Dyn Inc. press releases
- Remove HTML formatting from email

Under 'Security Image', there is a CAPTCHA image showing the numbers 0, 5, 3, 8, 8. Below the image is a text input field containing '05388'. At the bottom of the form, there is a checked checkbox for 'I agree with the acceptable use policy (AUP) and privacy policy.' and a 'Create Account' button. The 'Create Account' button is circled with a red dashed line.

- When you see this image, you'll receive an e-mail confirmation at the e-mail box you registered with dyndns.org.

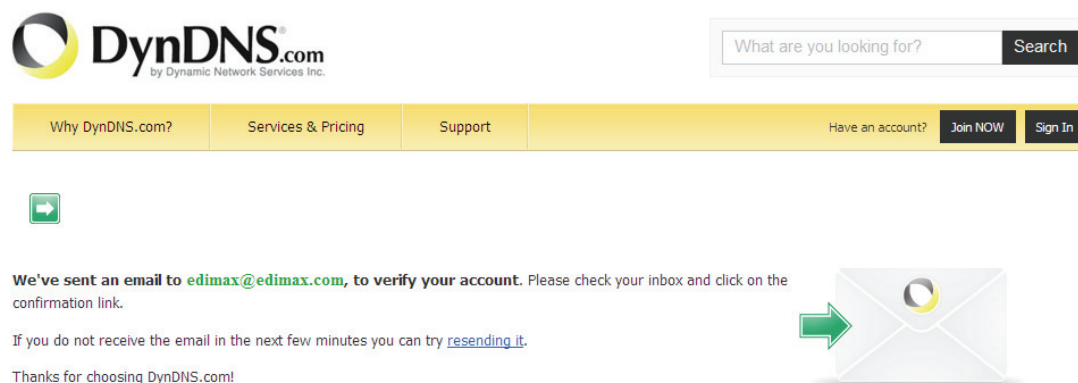

- Check your e-mail box and you should be able to get confirmation e-mail. Click the link to connect to dyndns.org website and complete registration procedure. If you didn't get the mail, please re-check the e-mail address, or click 'resending it' link in last step.

Also, if nothing happen after you click the link, please copy the link text and paste it in web browser's address bar.

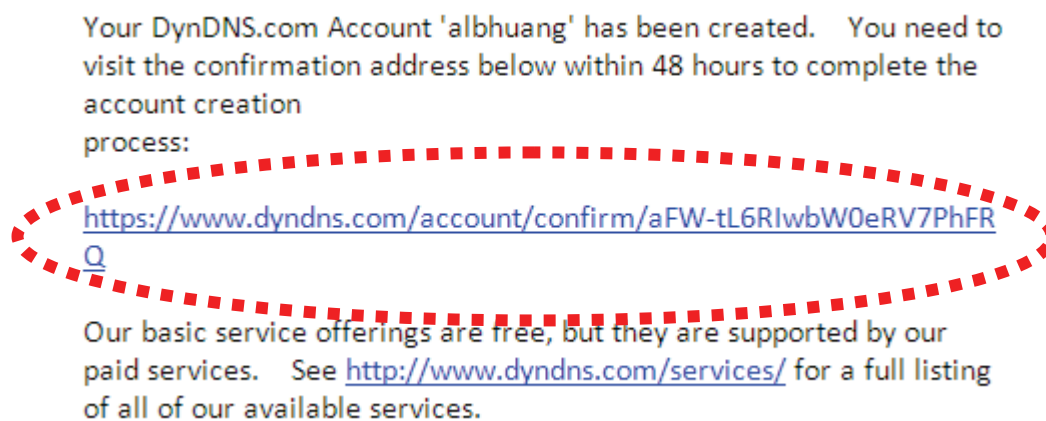

7. When you see 'Account Confirmed' webpage, indicates your dyndns.org account has been confirmed and activated. Now you can click 'Create a dynamic DNS host within our Free domains' link to continue.

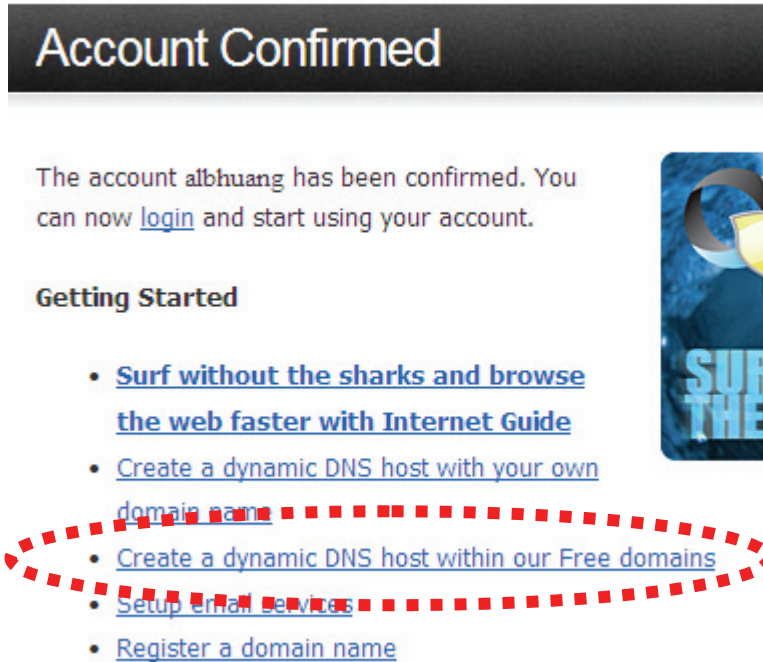

Account Confirmed

The account albhuang has been confirmed. You can now [login](#) and start using your account.

Getting Started

- [Surf without the sharks and browse the web faster with Internet Guide](#)
- [Create a dynamic DNS host with your own domain name](#)
- [Create a dynamic DNS host within our Free domains](#)
- [Setup email services](#)
- [Register a domain name](#)

8. Click 'Create Hostname' button.



Dynamic DNS Free

Stay Connected With DynDNS

DynDNS Free allows you to create a hostname that points to your home or office IP address, providing an easy-to-remember URL for quick access. We also provide an update mechanism which makes the hostname work with your dynamic IP address. We continue to offer this service free to the Internet community as we have done so for nearly 10 years.

Create Hostname

9. In this page:

Input the hostname of your choice in 'Hostname' field,
Select a domain name in dropdown menu,
Select 'Host with IP address' for 'Service Type',
Input current IP address in 'IP Address' field (or click the link below to use detected IP address to fill this field'.

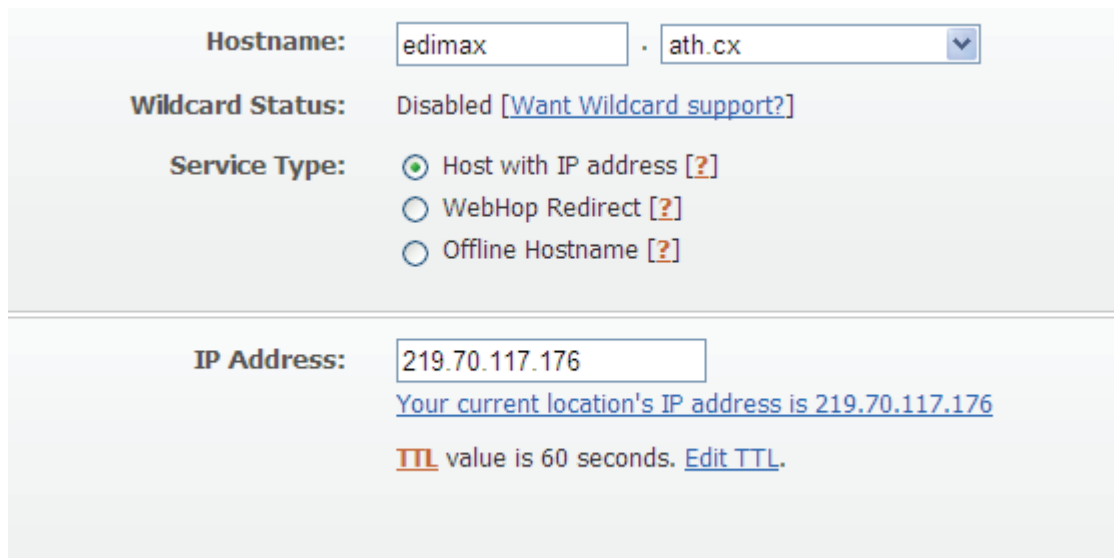

Hostname: edimax . ath.cx

Wildcard Status: Disabled [[Want Wildcard support?](#)]

Service Type:

- Host with IP address [?]
- WebHop Redirect [?]
- Offline Hostname [?]

IP Address: 219.70.117.176

[Your current location's IP address is 219.70.117.176](#)

TTL value is 60 seconds. [Edit TTL.](#)

10. Click 'Add to cart' continue.



What do you want to use this host for?
Select services and devices you would like to use with this hostname.

Work From Home Office or VPN:

- vpn
- remote file access
- remote desktop
- mail server
- web server
- chat server
- ftp backup
- ssh
- database
- voip

Hosting and Design For Web Sites and Blogs:

- blog
- gallery
- wiki
- portfolio
- ecommerce
- web page

Remote Access For Devices:

- dvr
- webcam
- data storage
- cctv
- printer
- alarm and security
- thermostat
- weather station
- game server
- home automation

[Add To Cart](#)

11. Click 'Next' to continue.

Your cart contains **free services only**. You will not be asked for credit card information.

Upgrade Options

Free accounts allow only five Dynamic DNS hosts.

- To add more and enjoy [additional benefits](#) for only \$15.00 per year, [purchase Dynamic DNS Pro](#).
- To get Dynamic DNS for **your own domain**, use [Custom DNS](#).

Dynamic DNS Hosts

edimax.ath.cx	-	<input type="button" value="remove"/>	\$0.00
-------------------------------	---	---------------------------------------	--------

Please enter coupons in the box below and click "Add Coupon".

<input type="text"/>	<input type="button" value="Add Coupon"/>	Sub-Total:	\$0.00	
			Order Total:	\$0.00

Would you like to [print an estimate/quote?](#)

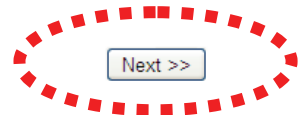

12. Click 'Activate Services' to continue.

Once you have confirmed the contents of your cart your services will be instantly activated.

Service	Period	Price
Dynamic DNS Hosts		
edimax1.ath.cx	-	\$0.00
Sub-Total:		\$0.00

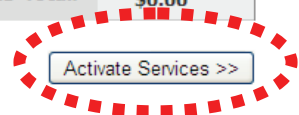

13. When you see this message, indicates your free dyndns.org hostname mapping service has been activated. You can go to chapter 2-2-3 to use your dyndns.org username, password, and hostname + domain name to locate your IP camera on Internet even you're using dynamic IP address!

[edimax.ath.cx](#) successfully activated.

Hostname	Service	Details	Last Updated
edimax.ath.cx	Host	219.70.117.176	May. 04, 2010 10:30 AM

[» Host Update Logs](#)

[» Bulk Update IP Address And Service Type](#)

4.5 Use this IPCAM with a router or firewall

If this IPCAM is not directly connected to Internet (behind router or firewall), you'll need to setup your router / firewall so you can access this IPCAM from other computers on Internet.

The following instruction describes how to configure your router or firewall device so your IPCAM can work with them. These instructions are based on a commonly-available residential router and these setup techniques should be easy to apply on any other similar devices as well.

4.4.1 Setup DynDNS Dynamic IP address Mapping

1. Go to your router's setup page, and locate 'DDNS', 'Dynamic DNS', or similar setup item.

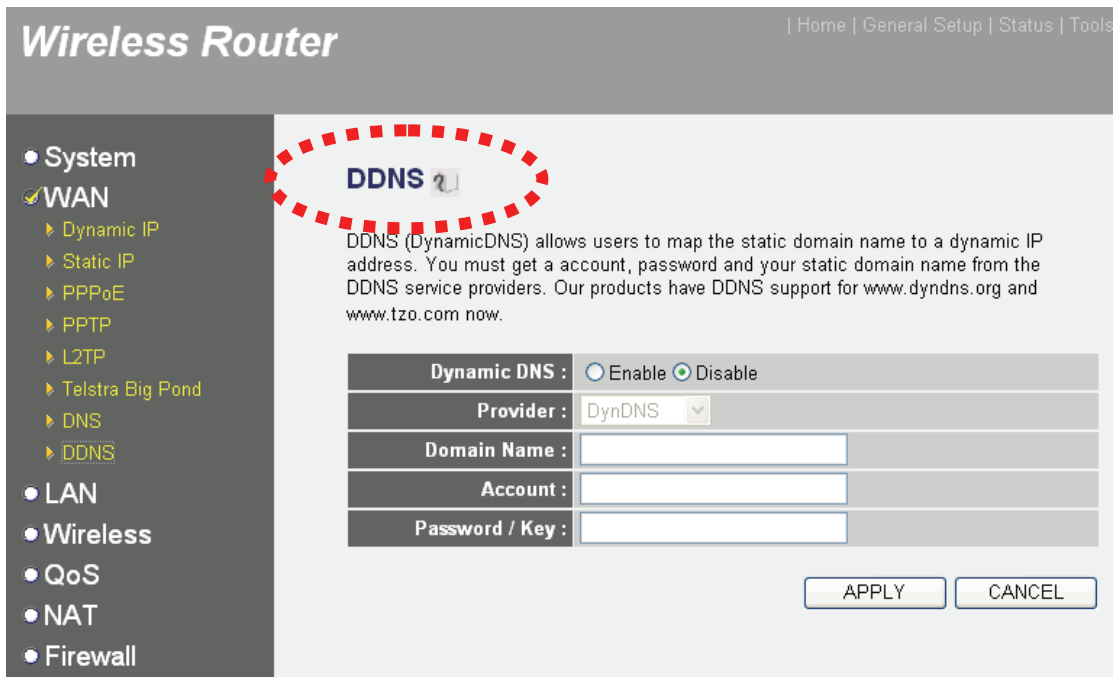

Wireless Router | Home | General Setup | Status | Tools

- System
- WAN
 - ▶ Dynamic IP
 - ▶ Static IP
 - ▶ PPPoE
 - ▶ PPTP
 - ▶ L2TP
 - ▶ Telstra Big Pond
 - ▶ DNS
 - ▶ **DDNS**
- LAN
- Wireless
- QoS
- NAT
- Firewall

DDNS ⓘ

DDNS (DynamicDNS) allows users to map the static domain name to a dynamic IP address. You must get a account, password and your static domain name from the DDNS service providers. Our products have DDNS support for www.dyndns.org and www.tzo.com now.

Dynamic DNS :	<input type="radio"/> Enable <input checked="" type="radio"/> Disable
Provider :	DynDNS ▾
Domain Name :	<input type="text"/>
Account :	<input type="text"/>
Password / Key :	<input type="text"/>

APPLY CANCEL

2. Refer to last chapter and obtain a DynDNS account, password, and domain name.

3. Enable Dynamic DNS function, select 'DynDNS' as service provider, and fill the information you obtained from DynDNS.org into Domain name, Account, and Password field (these field's name may differ on your router).

Dynamic DNS :	<input checked="" type="radio"/> Enable <input type="radio"/> Disable
Provider :	DynDNS ▼
Domain Name :	my-IPCAM.dynalias.com
Account :	myipcam
Password / Key :	••••••••

4.4.2 Open Ports Required by IP CAM

To access IP CAM located behind router or firewall, you must open ports on router or firewall so you can access IP CAM from Internet.

1. Go to your router's setup page, and locate 'NAT', 'Firewall', 'Port Mapping', 'Port Forwarding', or similar setup item.

- System
- WAN
- LAN
- Wireless
- QoS
- ✓ NAT
 - ▶ Port Forwarding
 - ▶ Virtual Server
 - ▶ Special Applications
 - ▶ UPnP Settings
 - ▶ ALG Settings
- Firewall

Port Forwarding

Entries in this table allow you to automatically redirect common network services to a specific machine behind the NAT firewall. These settings are only necessary if you wish to host some sort of server like a web server or mail server on the private local network behind your Gateway's NAT firewall.

Enable Port Forwarding

Private IP	Computer Name	Type	Port Range	Comment
<input style="width: 90%;" type="text"/>	<< -----Select----- >>	Both ▼	<input style="width: 80%;" type="text"/> <input style="width: 80%;" type="text"/>	<input style="width: 95%;" type="text"/>

• Current Port Forwarding Table

NO.	Computer Name	Private IP	Type	Port Range	Comment	Select
<input type="button" value="Delete"/> <input type="button" value="Delete All"/> <input type="button" value="Reset"/>						

2. Enable this function, and fill IP CAM's IP address in 'Private IP' (or similar field), select 'TCP' or 'BOTH' as data type, and input these port numbers for the services you wish to access from Internet:

IP CAM web configuration and view live image: 80

AV Control Port: 4321

RTSP: 554 and 50000 to 60000

Please note that if you changed the port number of web configuration / view or RTSP, you have to change the port forwarding setting for your router accordingly.

3. If IP CAM is the only one service you wish to access from Internet, you can also use 'DMZ' function to access IP CAM:

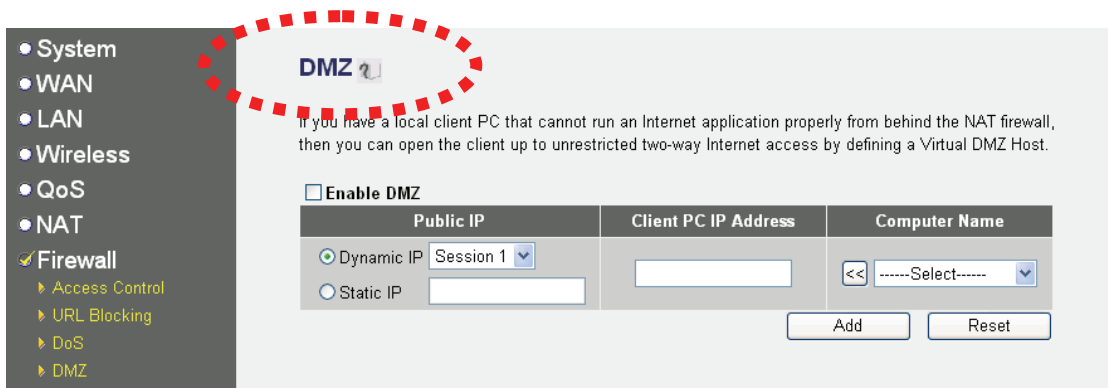

Simply fill the IP address of IP CAM and you can access IP CAM from the IP address of your router directly.

4.5 Using Cellphone as Image Viewer

You can use your cellphone to connect to this IP CAM and view captured image. Currently this IP CAM supports iPhone (Apple) and Google Android OS.

4.5.1 iPhone

1. Launch Safari web browser

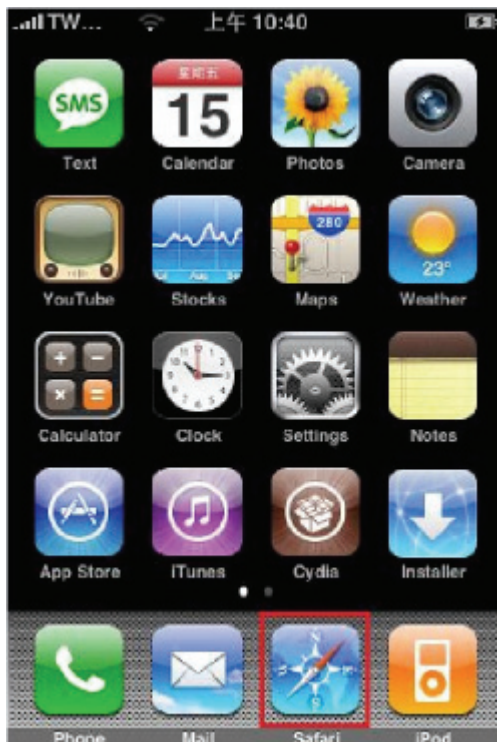

2. Input IP CAM's IP address / host name in safari's address bar in the following format:

111.222.333.444/ipcam.asp or hostname/ipcam.asp

Please note that appending '/ipcam.asp' is required.

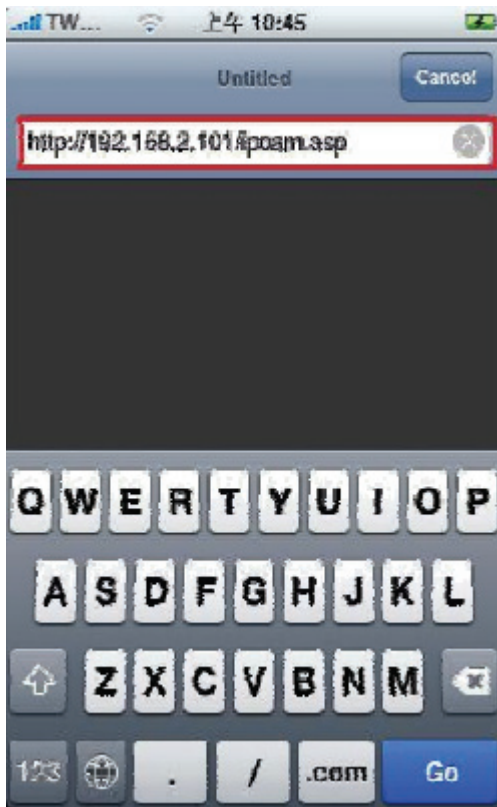

3. Input username / password to login.

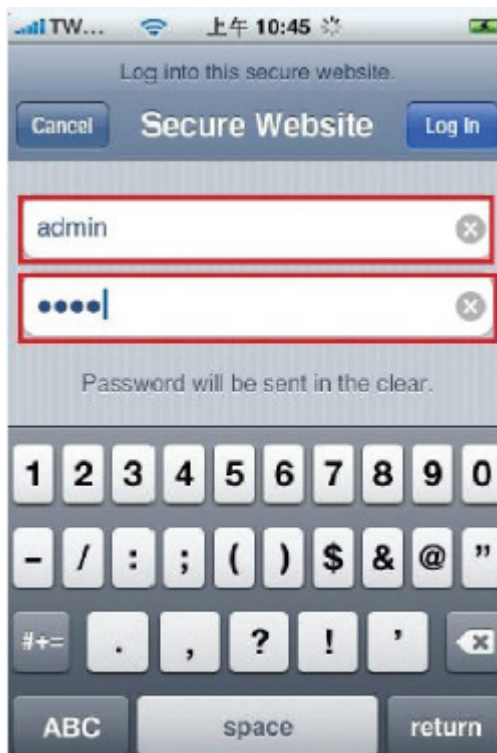

4. You'll see the image of connected camera displayed on upper-left corner of quad-split screen. If you have more than one IP CAM, you can add other 3 IP CAMs to the quad-split screen. Click an unused corner and a yellow square will appear to indicate it's being marked, then click 'Setting'.

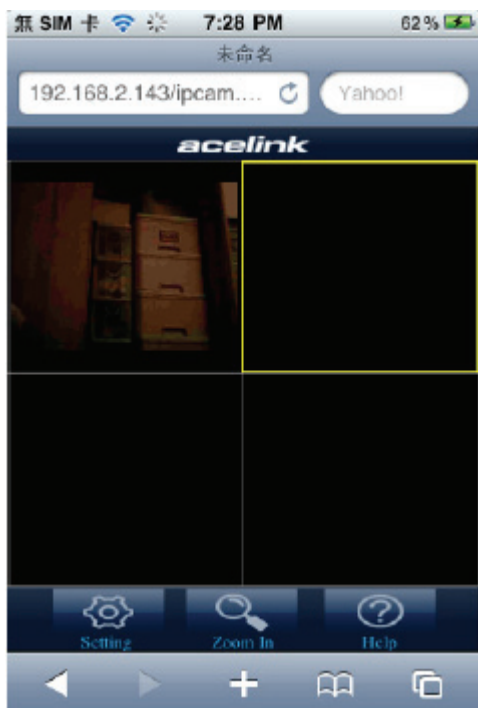

5. Click 'Camera Setting'.



6. Input camera's name, IP address, port number, username, and password in respective field, then click 'Done'. Please note that these fields are case-sensitive. You can click 'Preview' to check connection.



4.6 Windows Vista / Windows 7 UAC Configuration

When you attempt to save a snapshot or record video file, you will see UAC (User Account Control) pop-up notification window to restrict you from saving file like below:

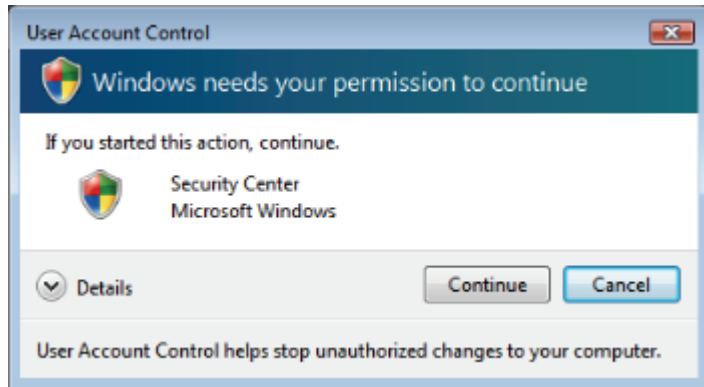

To avoid this from happening, you can:

- a. Switch UAC off in control panel (**NOT RECOMMENDED**)
- b. Select a lower security level in Internet Explorer's security setting (**NOT RECOMMENDED**)

- c. Add IP Camera's IP address to 'Trusted sites' in Internet Explorer's security setting (**RECOMMENDED**)

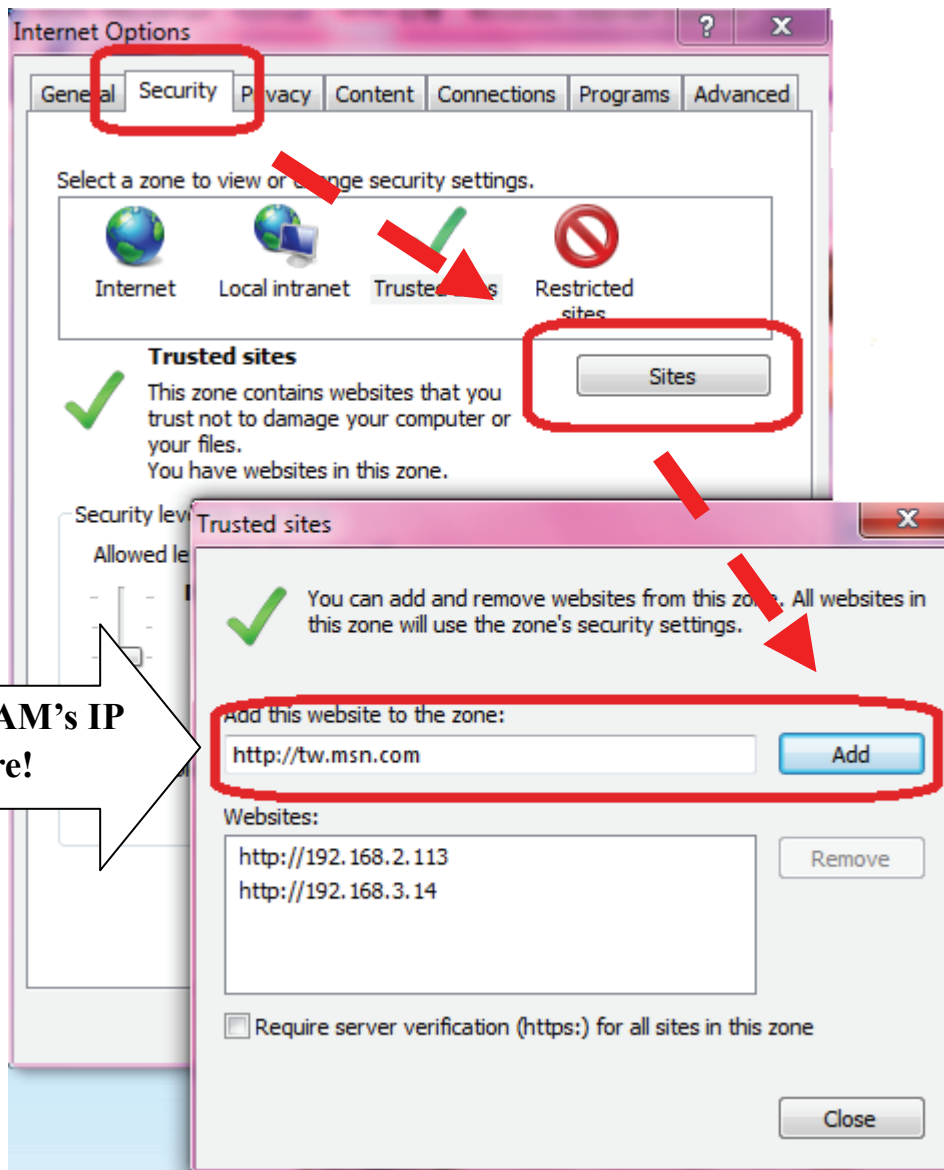

- d. If you don't want to change Internet explorer's security setting, you can run Internet explorer as administrator as workaround.

